

---

# Owner's Manual

---

## **ELECTRIC CHAIN HOIST SEQ SERIES**

1/8 tonne through 1 tonne Capacity

Code, Lot and Serial Number

### **⚠ WARNING**

This equipment should not be installed, operated, or maintained by any person who has not read and understood all the contents of this manual. Failure to read and comply with the contents of this manual can result in serious bodily injury or death, and/or property damage.

# **KITO**

# Table of Contents

Section	Page Number
1.0 Important Information and Warnings .....	4
1.1 Terms and Summary	
1.2 Warning Tags and Labels	
2.0 Technical Information.....	8
2.1 Specifications	
2.2 Dimensions	
3.0 Preoperational Procedures .....	11
3.1 Gearbox	
3.2 Chain	
3.3 Mounting Location	
3.4 Mounting the Hoist	
3.5 Electrical Connections	
3.6 VFD Setup (Dual Speed Only)	
3.7 Preoperational Checks and Trial Operation	
4.0 Operation .....	23
4.1 Introduction	
4.2 Shall's and Shall Not's for Operation	
4.3 Hoist Controls	
5.0 Inspection .....	27
5.1 General	
5.2 Inspection Classification	
5.3 Frequent Inspection	
5.4 Periodic Inspection	
5.5 Occasionally Used Hoists	
5.6 Inspection Records	
5.7 Inspection Methods and Criteria	

<b>Section</b>	<b>Page Number</b>
6.0 Maintenance & Handling .....	36
6.1 Count/Hour Meter	
6.2 Lubrication – Load Chain, Hooks and Suspension	
6.3 Lubrication – Gearbox	
6.4 Motor Brake	
6.5 Load Chain	
6.6 Friction Clutch	
6.7 Storage	
6.8 Outdoor Installation	
6.9 Operational Environment	
7.0 Troubleshooting .....	42
8.0 Warranty .....	45
9.0 Parts List .....	47

## 1.0 Important Information and Warnings

### 1.1 Terms and Summary

This manual provides important information for personnel involved with the installation, operation and maintenance of this product. Although you may be familiar with this or similar equipment, it is strongly recommended that you read this manual before installing, operating or maintaining the product.

#### Danger, Warning, Caution and Notice

Throughout this manual there are steps and procedures that can present hazardous situations. The following signal words are used to identify the degree or level of hazard seriousness.

**⚠ DANGER** Danger indicates an imminently hazardous situation which, if not avoided, **will** result in **death or serious injury**, and property damage.

**⚠ WARNING** Warning indicates an imminently hazardous situation which, if not avoided, **could** result in **death or serious injury**, and property damage.

**⚠ CAUTION** Caution indicates a potentially hazardous situation which, if not avoided, **may** result **minor or moderate injury** or property damage.

**NOTICE** Notice is used to notify people of installation, operation, or maintenance information which is important but not directly hazard-related.

### **⚠ CAUTION**

These general instructions deal with the normal installation, operation, and maintenance situations encountered with the equipment described herein. The instructions should not be interpreted to anticipate every possible contingency or to anticipate the final system, crane, or configuration that uses this equipment. For systems using the equipment covered by this manual, the supplier and owner of the system are responsible for the system's compliance with all applicable industry standards, and with all applicable federal, provincial and local regulations/codes.

This manual includes instructions and parts information for a variety of hoist types. Therefore, all instructions and parts information may not apply to any one type or size of specific hoist. Disregard those portions of the instructions that do not apply.

Record your hoist's Code, Lot and Serial Number (see **Section 9**) on the front cover of this manual for identification and future reference to avoid referring to the wrong manual for information or instructions on installation, operation, inspection, maintenance, or parts.

Use only KITO authorized replacement parts in the service and maintenance of this hoist.

## **WARNING**

Equipment described herein is not designed for and **MUST NOT** be used for lifting, supporting, or transporting people, or for lifting or supporting loads over people.

Equipment described herein should not be used in conjunction with other equipment unless necessary and/or required safety devices applicable to the system, crane, or application are installed by the system designer, system manufacturer, crane manufacturer, installer, or user.

Modifications to upgrade, rerate, or otherwise alter this equipment shall be authorized only by the original equipment manufacturer.

Equipment described herein may be used in the design and manufacture of cranes or monorails. Additional equipment or devices may be required for the crane and monorail to comply with applicable crane design and safety standards. The crane designer, crane manufacturer, or user is responsible to furnish these additional items for compliance. Refer to ANSI/ASME B30.17, "Safety Standard for Top-Running Single Girder Cranes"; ANSI/ASME B30.2 "Safety Standard for Top-Running Double-Girder Cranes"; and ANSI/ASME B30.11 "Safety Standard for Underhung Cranes and Monorails".

If a below-the-hook lifting device or sling is used with a hoist, refer to ANSI/ASME B30.9, "Safety Standard for Slings" or ANSI/ASME B30.20, "Safety Standard for Below-the-Hook Lifting Devices".

Hoists and cranes, used to handle hot molten material may require additional equipment or devices. Refer to ANSI Z241.2, "Safety Requirements for Melting and Pouring of Metals in the Metal Casting Industry".

Failure to read and comply with any one of the limitations noted herein can result in serious bodily injury or death, and/or property damage.

## **DANGER**

**HAZARDOUS VOLTAGES ARE PRESENT IN THE CONTROL BOX, OTHER ELECTRICAL COMPONENTS, AND CONNECTIONS BETWEEN THESE COMPONENTS.**

Before performing ANY mechanical or electrical maintenance on the equipment, de-energize (disconnect) the main switch supplying power to the equipment; as well as lock and tag the main switch in the de-energized position. Refer to ANSI Z244.1, "Personnel Protection – Lockout/Tagout of Energy Sources".

**These hoists incorporate a VFD as well as a Capacitor. Therefore, DO NOT perform ANY mechanical or electrical maintenance within 5 minutes of powering down to allow time for the capacitor inside the VFD to discharge. DO NOT perform any voltage or insulation resistance tests with a meg ohmmeter when the VFD is connected to the electrical circuit.**

Only trained and competent personnel should inspect and repair this equipment.

## **NOTICE**

It is the responsibility of the owner/user to install, inspect, test, maintain, and operate a hoist in accordance with ANSI/ASME B30.16, "Safety Standard for Overhead Hoists" and provincial OHS Regulations. If the hoist is installed as part of a total lifting system, such as an overhead crane or monorail, it is also the responsibility of the owner/user to comply with the applicable ANSI/ASME B30 volume that addresses that type of equipment and CSA B167-16.

It is the responsibility of the owner/user to have all personnel that will install, inspect, test, maintain, and operate a hoist read the contents of this manual and applicable portions of ANSI/ASME B30.16, "Safety Standard for Overhead Hoists". If the hoist is installed as part of a total lifting system, such as an overhead crane, the applicable ANSI/ASME B30 volume that addresses that type of equipment and CSA B167-16 must also be read by all personnel.

If the hoist owner/user requires additional information, or if any information in the manual is not clear, contact KITO or the distributor of the hoist. Do not install, inspect, test, maintain, or operate this hoist unless this information is fully understood.

A regular schedule of inspection of the hoist in accordance with the requirements of ANSI/ASME B30.16 should be established and records maintained.

## 1.2 Warning Tags and Labels

The warning tag illustrated below in **Figure 1-1** is supplied with each hoist shipped from the factory. If the tag is not attached to your hoist's pendant cord, order a tag from your dealer and install it. Read and obey all warnings attached to this hoist. Tag is not shown actual size.



**Figure 1-1** Warning Tag Attached to Hoist

## 2.0 Technical Information

### 2.1 Specifications

#### 2.1.1 Product Code

# SEQP 010 SD

#### Type:

SEQ = SEQ Hook Mount  
 SEQS = SEQ with Suspension Bar  
 SEQP = SEQ with Plain Trolley  
 SEQM = SEQ with Motorized Trolley

Capacity Code  
 (examples):  
 001 = 1/8 Ton  
 003 = 1/4 Ton  
 005 = 1/2 Ton  
 010 = 1 Ton

Lifting Speed:  
 SD = Std. Dual (VFD)

#### 2.1.2 Operating Conditions and Environment

Temperature range:	-20° to +40°C (-4° to +104°F)
Humidity:	85% or less
Noise Level:	80 dB or less (A scale: measured 1 meter away from electric chain hoist)
Enclosure Rating:	Hoist Meets IP55, Pendant Meets IP65
Supply Voltage:	Standard Re-connectable 115-1-60 (208-230)-1-50/60 (Single Phase)
Speed:	Dual (VFD)
ASME Duty Classification:	H4
Intermittent Duty Rating:	40/20% ED
Maximum Number Starts per Hour:	120/240
Short Time Duty Rating:	30/10 min.
Control Voltage:	24VDC
SCCR:	Suitable for use on a circuit capable of delivering not more than 5kA RMS symmetrical amperes, 230V maximum.

**Table 2-1** Hoist Specifications

Cap (tonne)	Product Code	Standard Lift (ft)	Push Button Cord L (ft)	Hoist Single Phase					Load Chain Diameter (mm) x Chain Fall	Net Weight (lbs)	Weight for Addition al One Foot of Lift (lbs)	
				Lifting Speed (ft/min)			Output (HP)	Rated Current (amps)				
				High	Low	No Load High Speed		@115V-60Hz				@230V-50/60Hz
1/8	SEQ001SD	10	8.2	56	9.3	72	0.67	10.8	5.7	5.6x1	71	0.48
1/4	SEQ003SD			33	5.5	43		12.1	6.4			
1/2	SEQ005SD			25	4.2	32		14.6	7.8			
1	SEQ010SD			17	3.9	30		18.7	9.9			



## 2.2 Dimensions

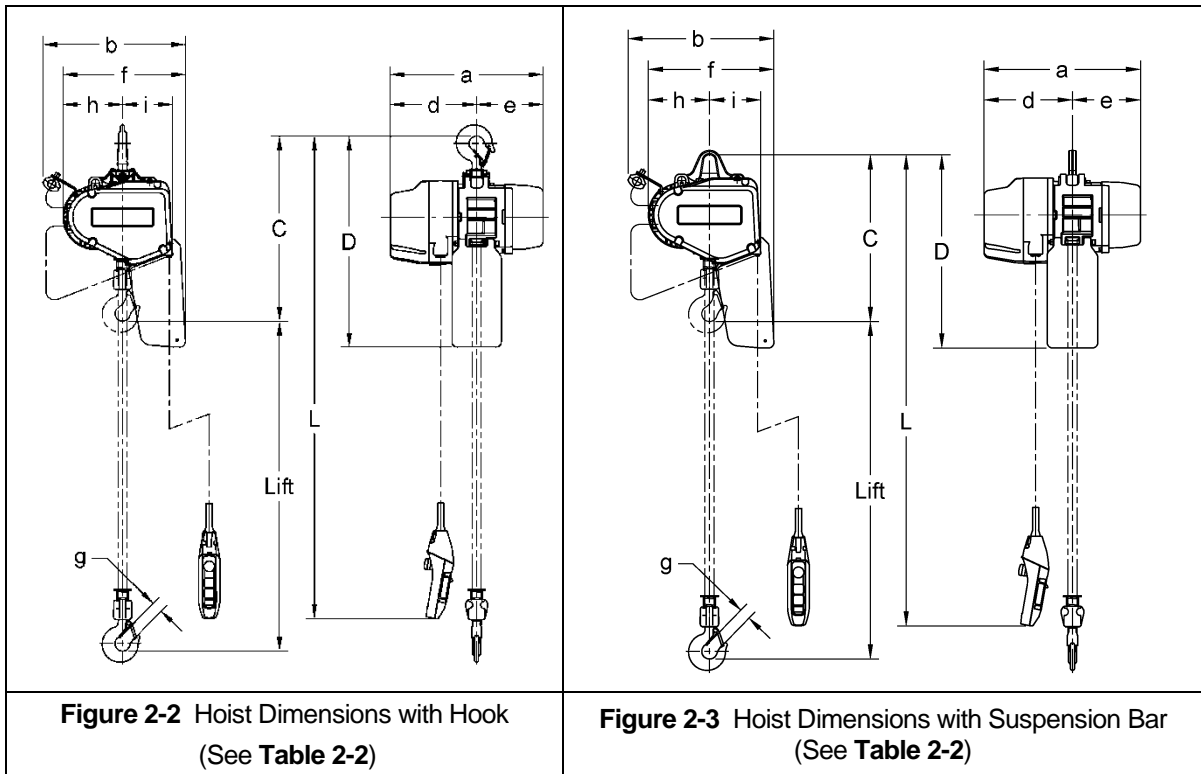

Table 2-2 Hoist Dimensions													
Capacity (tonne)	Product Code	Headroom C (in.)		D (in.)		a (in.)	b (in.)	d (in.)	e (in.)	f (in.)	g (in.)	h (in.)	i (in.)
		Top Hook	Susp. bar	Top Hook	Susp. bar								
1/8	SEQ001SD	17.3	15.6	21.0	19.1	16.4	14.4	9.1	7.4	11.7	1.1	5.4	5.0
1/4	SEQ003SD												
1/2	SEQ005SD	18.0	16.1	23.5	21.1	17.0	15.9	9.6	7.4	13.1	1.2	6.1	5.6
1	SEQ010SD	20.7	18.3										

Table 2-2 Hook Dimension*							
				T = Top Hook B = Bottom Hook Units = inch			
Capacity Code	Hook	a	b	c	d	e	g
SEQ001SD SEQ003SD SEQ005SD	T & B	1.1	0.7	0.9	0.7	1.4	1.1
SEQ010SD	T & B	1.5	0.9	1.2	0.9	1.7	1.2

\*Refer to Section 5.7 for inspection dimensions and limits.

Table 2-2 Suspension Bar Dimension*							
				Units = inch			
Capacity Code	a	b	c	d	e	f	g
SEQ001SD SEQ003SD SEQ005SD	5.5	2.7	0.6	0.7	0.6	1.3	0.5
SEQ010SD	6.0	2.8	0.6	0.6	0.9	1.3	0.5

\* Refer to Section 5.7 for inspection dimensions and limits

## 3.0 Preoperational Procedures

### 3.1 Gearbox

- 3.1.1 The gearbox is filled with the correct amount of oil at the time of shipment. The oil level must be verified prior to operation. Refer to **Section 6.3** for specific checking procedures.
- 3.1.2 Refer to **Section 6.3** when replacing the gear oil.

### 3.2 Chain

- 3.2.1 Never operate the hoist with incorrect, missing, or damaged chain components. Ensure that all chain components are in the correct location and properly installed as shown in **Figure 3-1** and **Figure 3-2**. Make sure the chain remains free of twists and the chain Stopper is installed on the correct link.

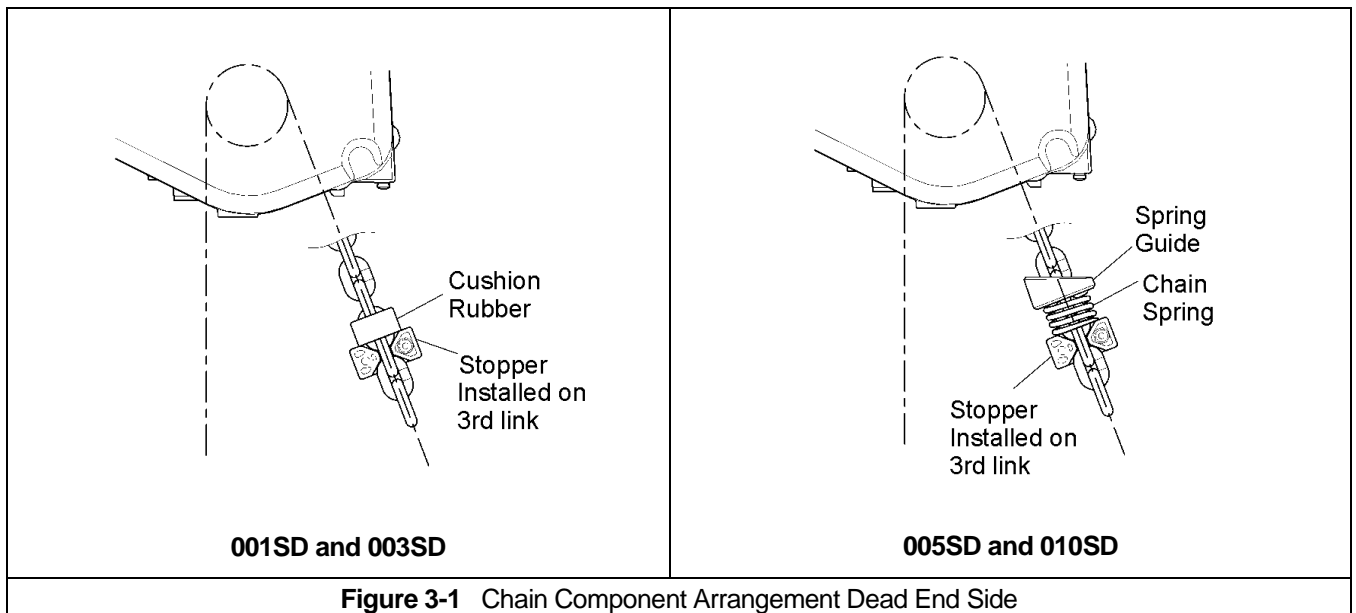

\*Tightening torque for the Stopper Bolt: 10.8 N-m (8.0 lb-ft)

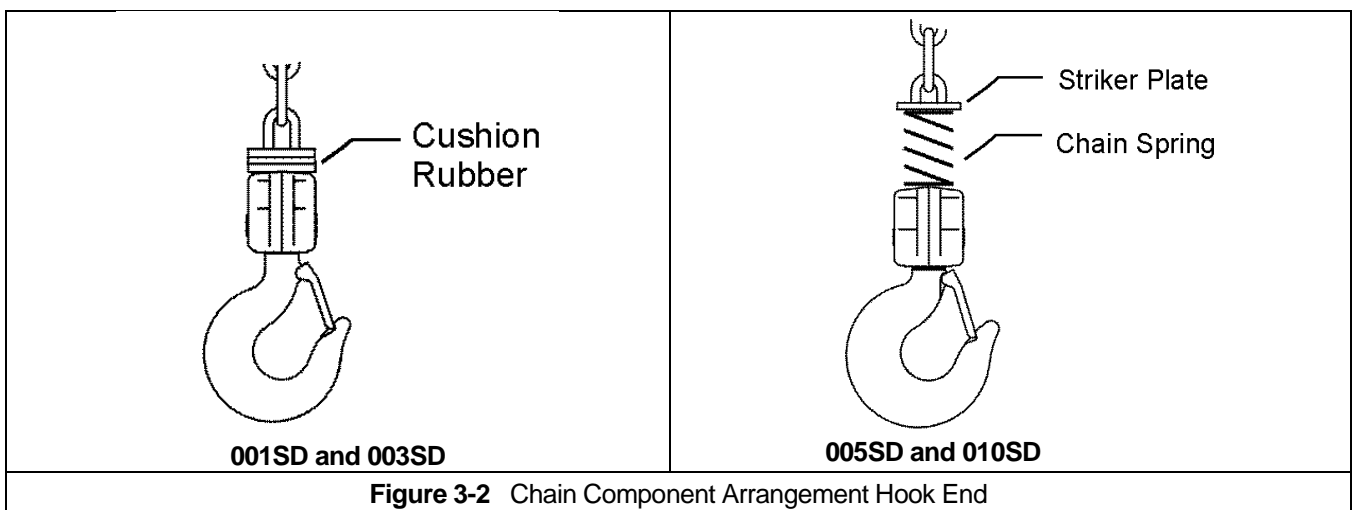

\*Tightening torque for the hook yoke bolts: 19.6 N-m (14.5 lb-ft) for 001SD, 003SD, and 005SD  
34.3 N-m (25.3 lb-ft) for 010SD

3.2.2 Standard Plastic Chain Container (all capacities) or optional Canvas Chain Container (1/8 t, 1/4 t and 1/2 t capacities only). When the optional canvas chain container is selected, fully unfold and install it on the hoist body as shown in **Figure 3-3**. The free end of the chain is not attached to the hoist body and the chain stopper is installed on the third link from the free end (see **Figure 3-1**). To place the chain into the chain container, feed the free end of the chain into the container. Take care to avoid twisting or tangling the chain. NEVER put all the chain into the container at once. Lumped or twisted chain may activate the down limit switch and stop the hoist during lowering.

3.2.3 **CAUTION** Each chain container is designed for a specific maximum length of the load chain that can be stored in the container. The amount of chain the container must hold is equal to the lift on the hoist. DO NOT use a chain container with a storage capacity less than the lift length on the hoist. If all of the chain cannot be stored in the container, the limit switch will not operate properly.

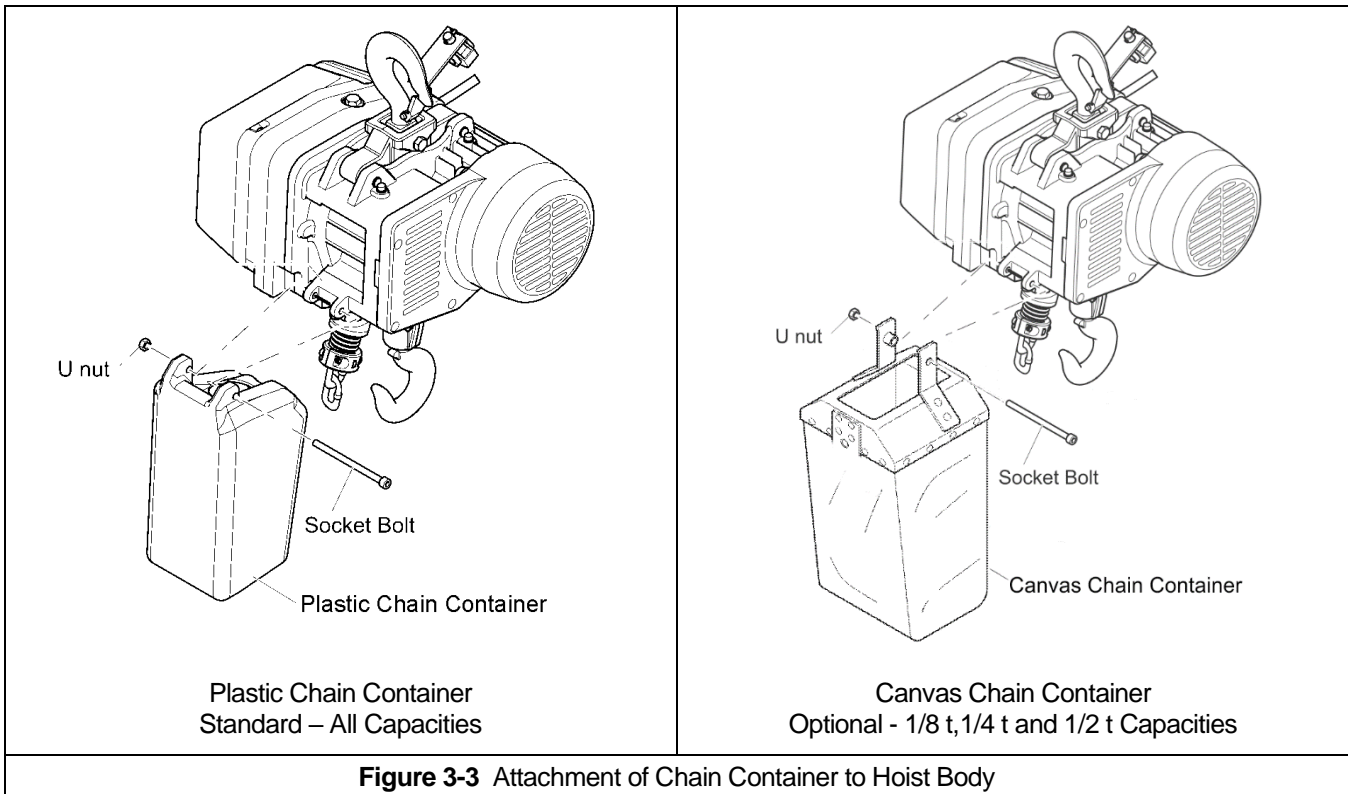

### 3.3 Mounting Location

3.3.1 **⚠ WARNING** Prior to mounting the hoist, ensure that the suspension and the supporting structure are adequate to support the hoist and its loads. If necessary, consult a professional that is qualified to evaluate the adequacy of the suspension location and its supporting structure.

3.3.2 **NOTICE** See **Section 6.8** for outdoor installation considerations.

### 3.4 Mounting the Hoist

3.4.1 Manual Trolley – Connection with a trolley requires the Suspension Bar which orients the hoist perpendicular to the beam. If the hoist is not equipped with the Suspension Bar, remove the Top Hook Assembly from the hoist and install the Suspension Bar as follows in steps 1 through 4.

- 1) Refer to Figure 3-4.
- 2) Remove the Screws. Remove Top Pins.
- 3) Remove the Top Hook Assembly and replace it with the Suspension Bar.
- 4) Reinstall the Top Pins and Screws. Torque screws 96 (in.lb).

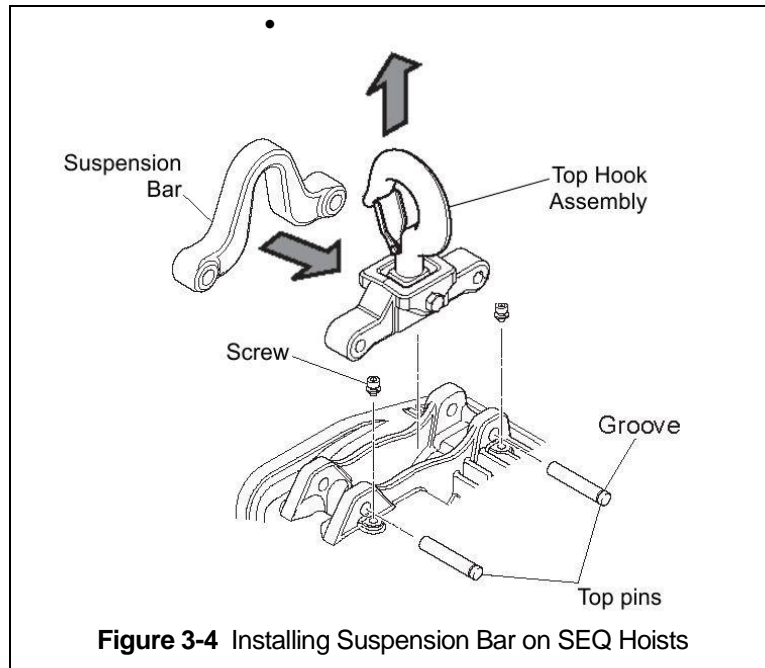

**Figure 3-4** Installing Suspension Bar on SEQ Hoists

When coupling the hoist to a trolley with the Suspension Bar, an additional 2 thin spacers (Thin Spacer L) will be provided and they must be installed on either side of the Suspension Bar to prevent lateral movement.

Spacer Dimensions (mm)		1/8 – 1/2t	1t
<b>Thin Spacer L (manual trolley)</b>	width	5.5	3.2
	outside diameter	42.7	54
	inside diameter	22.7	26
<b>Thin Spacer L (motorized trolley)</b>	width	5.5	
	outside diameter	50.8	
	inside diameter	32.8	

3.4.2 Motorized Trolley - Follow instructions in Owner's Manual provided with the trolley.

3.4.3 Hook Mounted or Suspension Bar to a Fixed Location - Attach the hoist's top hook or suspension bar to the fixed suspension point.

3.4.4 **⚠ WARNING** Ensure that the fixed suspension point rests on the center of the hook's saddle and that the hook's latch is engaged.

### 3.5 Electrical Connections

3.5.1 **⚠ CAUTION** Ensure that the voltage of the electric power supply is proper for the hoist or trolley. The SEQ hoist is voltage reconnectable between 115V or 230V through a device called the DPC (Dual Power Converter). Supplying the hoist with incorrect power supply could result in property damage and/or injury. Refer to **Section 3.5.7** for voltage change instructions.

3.5.2 **⚠ CAUTION** Do NOT apply electronic soft-start control or voltage varying controls. Use of such devices may cause the motor brake and other electrical components to malfunction.

3.5.3 **⚠ DANGER** Before proceeding, ensure that the electrical supply for the hoist or trolley has been de-energized (disconnected). Lock out and tag out in accordance with ANSI Z244.1 "Personnel Protection - Lockout/Tagout of Energy Sources".

3.5.4 **⚠ DANGER** To avoid a shock hazard, **DO NOT** perform **ANY** mechanical or electrical maintenance on the trolley or hoist within 5 minutes of de-energizing (disconnecting) the trolley or hoist. This time allows the internal VFD capacitor to safely discharge.

3.5.5 **⚠ DANGER** Do NOT remove power to the hoist or trolley during operation.

3.5.6 **⚠ CAUTION** All hoists are equipped with a VFD. The VFD is used to control the high and low lifting speeds. The speeds come preset from the factory (See **Table 3-6**). Speed (frequency) can be customized. Refer to **Section 3.6.10** for hoist specific speed ranges and instructions.

### 3.5.7 VOLTAGE CHANGE -

**⚠ DANGER** Follow all preceding warnings in **Section 3.5** before performing a voltage change.

#### **For 115V Power Supply**

- Refer to **Figure 3-8**
- Locate the DPC device directly next to the Variable Frequency Drive (VFD)
- Ensure the white wire lead (labeled P1 at its origin) is connected to the CN3 (115V) location. If not, disconnect wire and relocate to the CN3 (115V) location.
- Ensure voltage label on outside of the control cover reflects 115V.

#### **For 230V Power Supply**

- Refer to **Figure 3-8**
- Locate the DPC device directly next to the Variable Frequency Drive (VFD)
- Ensure the white wire lead (labeled P1 at its origin) is connected to the CN2 (230V) location. If not, disconnect wire and relocate to the CN2 (230V) location.
- Ensure voltage label on outside of the control cover reflects 230V.

### 3.5.8 POWER SUPPLY AND PENDANT CONNECTIONS –

**⚠ DANGER** Follow all preceding warnings in **Section 3.5** before connecting power supply or pendant.

**NOTICE** The following instructions apply when the hoist is hook or suspension bar mounted to a fixed suspension point or installed on a manual trolley. The hoist is controlled by a pendant with two push buttons – one for raising and one for lowering.

#### **Pendant Cord**

The Pendant Cord connects to the hoist using a Cable Holder Assembly and a 6P Plug and Socket. Make this connection as follows:

- Refer to **Figure 3-7**.
- Insert pendant cable (as shown in **Figure 3-7** with Holder A and Cable Packing) through Holder B which is installed in hoist body.
- Insert the 6P Plug located at the end of the pendant cable into the 6P Socket on the hoist and hand-tighten Holder A to Holder B.
- Attach the Cord Strain Relief Cable to the Cord Support on the bottom of the hoist.

#### **Power Supply Cable - Hoist Connection**

The Power Supply Cable connects to the hoist using a Cable Holder Assembly and a hard wire connection. Make this connection as follows:

- Refer to **Figure 3-7** and **Figure 3-8**.
- Insert the Power Supply Cable (as shown in Figure 3.7 with Holder A and Cable Packing) through Holder B which is installed in the hoist body.
- Install the White wire and Black wire, of the power supply cable, on the C1 terminal location of the DPC as shown in **Figure 3-8**.
- Install Ground wire, of the power supply cable, as shown in **Figure 3-8**.
- Install the Cable Support Arm (pre-installed on the Power Supply Cable) on to the Socket Holder using the pre-installed Machine Screws and Lock Washers.
- Use care to avoid twisting or kinking the Power Supply Cable

#### **Power Supply Cable - Installation**

If the hoist is hook mounted to a fixed support ensure that the Power Supply Cable is properly installed and supported between the hoist and the electrical power supply.

If the host is installed on a manual trolley, then the Power Supply Cable must be installed along the beam that the trolley runs on. For curved beams a special cable suspension system will be needed, and this instruction does not apply. For straight beams install the Power Supply Cable as follows:

- Install a guide wire system parallel to the beam.
- For a manual trolley the guide wire should be positioned slightly outside the hoist's Cable Support as shown in **Figure 3-7**.
- Use the Cable Trolleys supplied with the hoist to suspend the Power Supply Cable from the guide wire. Space the Cable Trolleys every 5 feet.

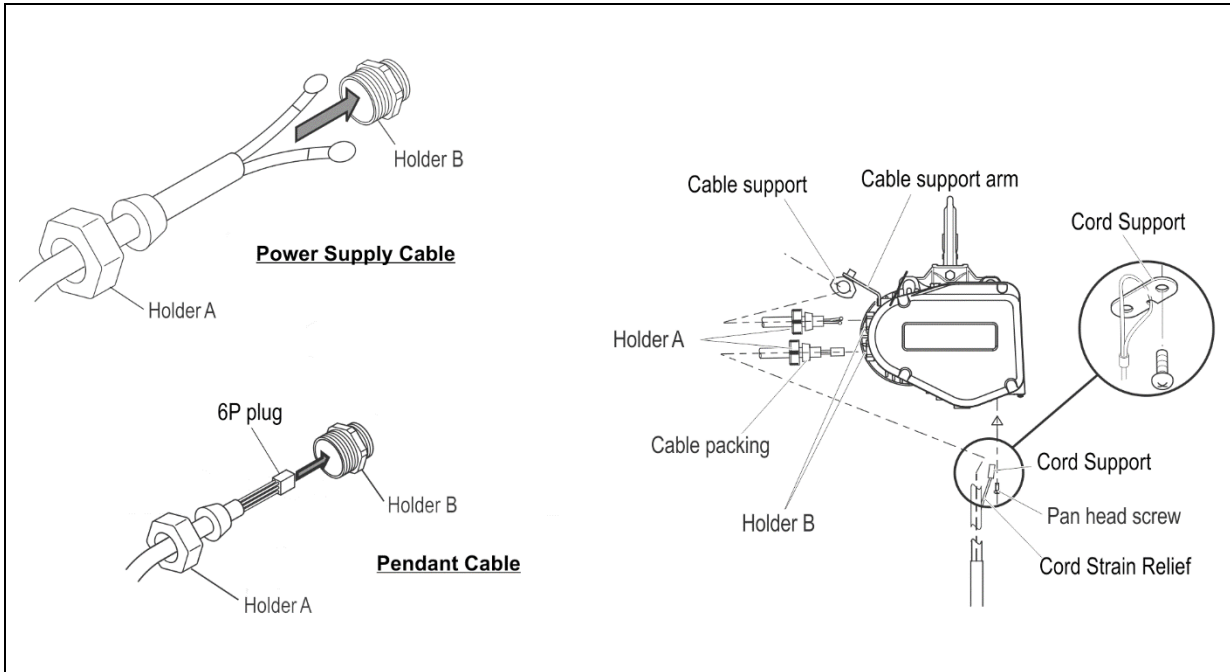

**Figure 3-7** Pendant and Power Supply Cable Connections

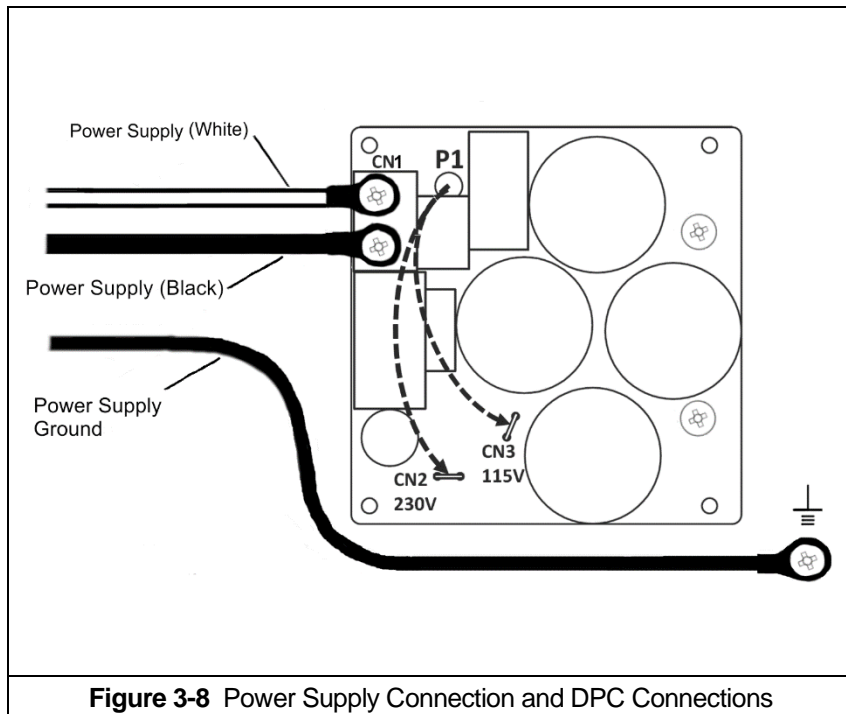

**Figure 3-8** Power Supply Connection and DPC Connections



- 3.5.9 Connection to Electrical Power Source - The white and black wires of the Power Supply Cable should be connected to an Electric Power Disconnect Switch or Circuit Breaker.
- 3.5.10 Fuse/Breaker Capacity -The hoist's power supply should be equipped with current overload protection such as fuses, which should be selected for 110% to 120% of total listed full load amperage, and should be dual element time-delay fuses. Refer to the motor nameplate for the full load amperage draw.
- 3.5.11 **⚠ DANGER** Grounding - An improper or insufficient ground connection creates an electrical shock hazard when touching any part of the hoist or trolley. In the Power Supply Cable the ground wire will be either Green with Yellow stripe or solid Green. It should always be connected to a suitable ground connection. Do not paint the trolley wheel running surfaces of the beam as this can affect grounding.

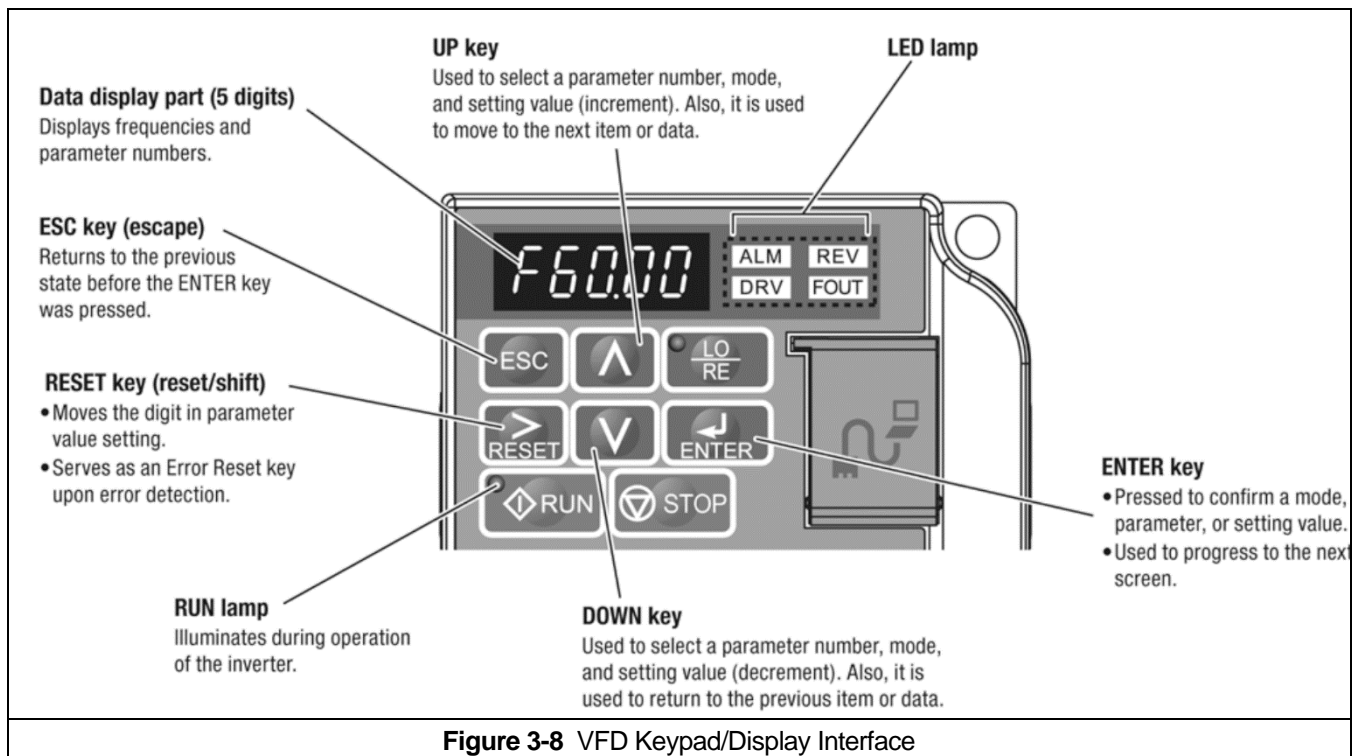

### 3.6 VFD Setup

- 3.6.1 **⚠ DANGER** To avoid a shock hazard, **DO NOT** perform **ANY** mechanical or electrical maintenance on the trolley or hoist within 5 minutes of de-energizing (disconnecting) the trolley or hoist. This time allows the internal VFD capacitor to safely discharge.
- 3.6.2 **⚠ WARNING** Do Not remove power to hoist or trolley during operation.
- 3.6.3 All hoists are equipped with a VFD. The VFD is used to control the high and low lifting speeds. The speeds come preset from the factory (**Table 3-6**). Speed (frequency) can be customized. Refer to **Section 3.6.10** for hoist specific speed ranges and instructions.
- 3.6.4 The VFD is controlled by a Keypad/Display Interface. Refer to **Figure 3-8** for Keypad/Display Interface functions and descriptions.

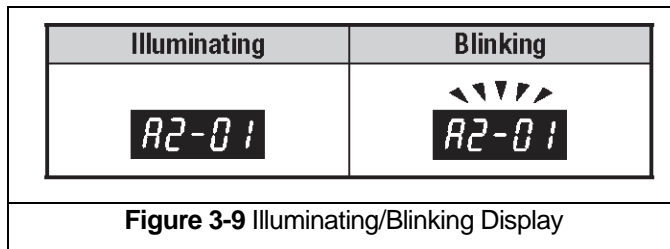

**Figure 3-8** VFD Keypad/Display Interface

3.6.5 When power is supplied to the hoist the VFD LED operator display will illuminate as shown **Table 3-2**.

No	Name	Description
Normal		The frequency command monitor is displayed in the data display part. <b>DRV</b> illuminates.
Error	 Example: Main circuit low voltage	The display varies depending on the error. <b>ALM</b> and <b>DRV</b> illuminate.

3.6.6 During operation the data display will exhibit illuminating or blinking data as shown in **Figure 3-9**.



3.6.7 The digital display uses a seven segment character to form the specific characters used in the display. **Table 3-3** shows the corresponding digital characters to its English equivalent.

Character	LED display	Character	LED display	Character	LED display	Character	LED display
0	0	9	9	I	,	R	r
1	1	A	A	J	J	S	S
2	2	B	b	K	k	T	T
3	3	C	C	L	L	U	U
4	4	D	d	M	m*	V	v
5	5	E	E	N	n	W	W*
6	6	F	F	O	o	X	No display
7	7	G	G	P	P	Y	Y
8	8	H	H	Q	q	Z	No display

\*Display uses 2 digits.

3.6.8 The LED Lamp display provides hoist status. **Table 3-4** shows some of the status displays.

Lamp	Illuminating	Blinking	Off
<b>ALM</b>	Upon error detection	<ul style="list-style-type: none"> <li>• Upon detection of minor failure</li> <li>• Upon detection of an OPE (operation error)</li> </ul>	Normal
<b>REV</b>	Inputting a reverse rotation command	-	Inputting a forward rotation command
<b>DRV</b>	In the drive mode	-	In the program mode
<b>FOUT</b>	Displaying output frequency (Hz)	-	-
Description in this document			

3.6.9 The Run Lamp display provides hoist “RUN” status. **Table 3-5** shows the various “RUN” displays.

Lamp	Illuminating	Blinking	Short blinking	Off
	During operation	<ul style="list-style-type: none"> <li>• During deceleration/ stop</li> <li>• Inputting a driving command with the frequency command 0</li> </ul>	<ul style="list-style-type: none"> <li>• During deceleration due to an emergency stop</li> <li>• During deceleration</li> <li>• During a stop due to driving interlock operation</li> </ul>	During a stop
Description in this document				

3.6.10 All of the hoists have speed/frequency ranges that can be customized to a specific application. Refer to **Table 3-6** for specific hoist speed/frequency ranges. To set custom speeds for an application, follow the procedure listed in **Table 3-7**.

Product Code	Table 3-6 Hoist Speed and VFD Frequency Ranges				
	Lifting Speed <sup>1</sup> (ft/min)			VFD Frequency <sup>1</sup> (Hz)	
	Low	High	No Load High Speed <sup>2</sup>	Low (d1-01)	High (d1-02)
				115V/230V	115V/230V
SEQ001SD	9.3	56	72	8.6	56.1
SEQ003SD	5.5	33	43	8.3	56.1
SEQ005SD	4.2	25	32	9.0	56.5
SEQ010SD	3.9	17	30	8.8	39.8





















1) The factory standard minimum and maximum speed/frequency range (6:1 ratio).

2) No Load High Speed feature is not an adjustable parameter. It can be turned on/off using **Table 3-8**.

**Table 3-7 VFD Speed/Frequency Change Procedure**

**⚠ CAUTION**

- Each dual speed hoist model has a range of available speeds/frequencies (upper and lower limits). Any value outside the range listed in **Table 3-6** for your specific hoist is strictly prohibited.
- Speeds must be set such as Low [d1-01] and High [d1-02].
- After parameters are changed, a “no load” operational check must be performed.

Operational Step	VFD Display
1. Energize the hoist.	
2. Press  until the “Setup Mode” screen is displayed (blinking).	
3. Press  to display the parameter setting screen (blinking).	
4. Press  or  until the desired parameter is displayed (blinking). (Low Speed: d1-01, High Speed: d1-02)	
5. When you press  , the current setting value is displayed (digit selected blinks). (Example Value: 9 Hz)	
6. Press  to move the blinking digit to the desired digit. (Example Value: 9 blinks)	
7. Press  or  until the desired setting is displayed and press  .	
8. Press  to confirm the new setting.	
9. The display will automatically return to the parameter screen (blinking). (As in Step 4.)	
10. Press  until the display returns to the initial screen. (As in Step 1.)	

- 3.6.11 All hoists come equipped with the No-Load High Speed Function. This allows the hoist to operate in the lifting and lowering direction 1.3 times faster than the standard high speed (SEQ001SD, SEQ003SD and SEQ005SD) and 1.8 times faster than the standard high speed (SEQ010SD). This function is automatically activated when the hoist is operating at 30% or less its full capacity. Refer to **Table 3-8** for the procedure to enable or disable the No-Load High Speed function.

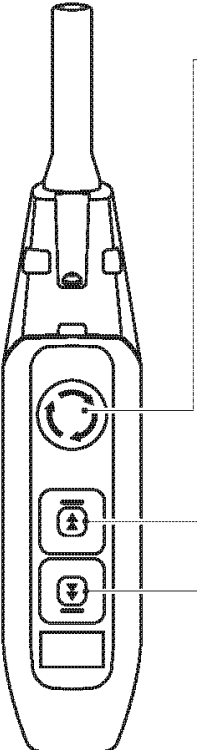
<b>Table 3-8</b> Hoist VFD No Load High Speed Enable/Disable	
<p><b><u>Enabling the No-Load High Speed Function</u></b></p> <ol style="list-style-type: none"> <li>1. Operate hoist in the down direction until the lower limit switch is activated.</li> <li>2. Press the Emergency Stop button.</li> <li>3. Press and hold the Down Button in the <b>low speed</b> position, for 5 seconds or more.</li> <li>4. Release the Emergency Stop button. (turn clockwise)</li> </ol> <p><b><u>Disable the No-Load High Speed Function</u></b></p> <ol style="list-style-type: none"> <li>1. Operate hoist in the down direction until the lower limit switch is activated.</li> <li>2. Press the Emergency Stop button.</li> <li>3. Press and hold the Down Button in the <b>high speed</b> position, for 5 seconds or more.</li> <li>4. Release the Emergency Stop button. (turn clockwise)</li> </ol>	 <p>The diagram shows a vertical control panel for a hoist. At the top is a long, thin emergency stop button. Below it are three circular buttons: the top one is the 'Up Button' with an upward-pointing arrow, the middle one is the 'Down Button' with a downward-pointing arrow, and the bottom one is a smaller button with a circular arrow icon. Lines connect the text labels to their respective buttons.</p>

- 3.6.12 “Hbb” will appear on the dual speed unit’s VFD display when the Emergency Stop Button is depressed. Turn the Emergency Stop Button clockwise to unlock the controls and allow hoist operation.
- 3.6.13 Hoist is equipped with a factory set Overload Limiter within the Variable Frequency Drive. In the event that a load test of up to 125% rated capacity is necessary, the Overload Limiter may require an adjustment to allow the load test to take place. Before making any adjustment, try to perform load test. If the test load of a maximum of 125% of rated capacity, cannot be lifted, follow the steps in **Table 3-9**.

**⚠ WARNING** **LOAD LIMITER MUST BE SET TO FACTORY SPECIFICATIONS PRIOR TO HOIST BEING PLACED INTO SERVICE. FAILURE TO DO SO WILL PREVENT HOIST FROM FUNCTIONING PROPERLY IN THE EVENT OF AN OVERLOAD CONDITION.**

**Table 3-9** VFD Overload Limiter Adjustment Procedure For Load Testing

**⚠ WARNING**

- Attempt load test prior to making any adjustments. If test load of a maximum of 125% of rated capacity, cannot be lifted, follow steps 1 through 14 shown below using free weights.
- Never put hoist into service without Overload Limiter set to factory specification values.



























Operational Step	VFD Display
1. Energize the hoist.	
2. Press  until the "Setup Mode" screen is displayed (blinking).	
3. Press  to display the parameter setting screen (blinking).	
4. Press  or  until the S1-38 parameter is displayed (blinking).	
5. Press  , the current S1-38 Load limit factory setting value is displayed. (Example: In <b>Table 3-10</b> , the S1-38 Factory Setting Value for EQ 460V 1t Capacity = 101)	See <b>Table 3-10</b>
6. Press  to move the blinking digit to the desired digit to change. (009.00 shown for example purposes only.)	
7. See <b>Table 3-10</b> for appropriate S1-38 setting to allow a load test up to 125% rated capacity. Press  or  until the desired setting is displayed and press  . (Example: In <b>Table 3-10</b> , the S1-38 for 125% Load Test for EQ 460V 1t Capacity = 121)	See <b>Table 3-10</b>
8. Press  , to confirm the new setting. The display will automatically return to the parameter screen (blinking). (As in Step 4.)	
9. Press  or  until "S1-41" is displayed and press  , the current "S1-41 Load Limit factory setting value is displayed. (Example: In <b>Table 3-10</b> , the <b>S1-41</b> Factory Setting Value for EQ 460V 1t Capacity = 128.5)	See <b>Table 3-10</b>
10. Press  to move the blinking digit to the desired digit to change. (009.00 shown for example purposes only)	
11. See <b>Table 3-10</b> for appropriate S1-41 setting to allow a load test up to 125% rated capacity. Press  or  until the desired setting is displayed and press  . (Example: In <b>Table 3-10</b> , the S1-41 for 125% Load Test for EQ 460V 1t Capacity = 150.5)	See <b>Table 3-10</b>
12. Press  until the display returns to the initial screen. (As in Step 1.)	
13. Perform Load Test	
14. Reset Load Limiter to factory setting by repeating steps 2 through 13, using the S1-38 Factory Setting Value and S1-41 Factory Setting Value as shown in <b>Table 3-10</b> . <b>⚠ WARNING</b> Failure to reset Load Test Setting Values back to Factory Setting Values, will prevent hoist from functioning properly in the event of an overload condition. DO NOT put hoist into service without Over Load Limiter set to factory settings.	See <b>Table 3-10</b>

Table 3-10: Factory Setting Values and 125% Load Test Setting Values						
Model	Voltage class (V)	Capacity (tonne)	Factory Setting Value		125% Load Test Setting Values	
			S1-38	S1-41	S1-38	S1-41
EQ	200	1/8	84	99	104	119
		1/4	92	109.5	112	129.5
		1/2	107.5	126.8	127.5	152.8
		1	99.5	110.5	119.5	130.5
	400	1/8	71	93	95.6	113
		1/4	85	106.4	105	126.4
		1/2	118.6	139.6	138.6	159.6
		1	101	128.5	121	150.5
SEQ	115/230	1/8	84	99	104	119
		1/4	92	109.5	112	129.5
		1/2	107.5	126.8	127.5	152.8
		1	99.5	119.5	107.5	127.5

### 3.7 Preoperational Checks and Trial Operation

- 3.7.1 **⚠ WARNING** Confirm the adequacy of the rated capacity for all slings, chains, wire ropes and all other lifting attachments before use. Inspect all load suspension members for damage prior to use and replace or repair all damaged parts.
- 3.7.2 **⚠ WARNING** Verify and correct all chain irregularities prior to operating the hoist. Refer to **Section 3.2**.
- 3.7.3 Measure and record the “k” dimension of all hooks on hoist. See **Table 5-4** under **Section 5**, “Inspection”.
- 3.7.4 Record the hoist's Code, Lot and Serial Number (from the name plate on the hoist; see **Section 9**) in the space provided on the cover of this manual.
- 3.7.5 Ensure that the hoist is properly installed to either a fixed point, or trolley, whichever applies.
- 3.7.6 If hoist is installed on a trolley, ensure that
- trolley is properly installed on the beam, and
  - stops for the trolley are correctly positioned and securely installed on the beam.
- 3.7.7 Ensure that all nuts, bolts and split pins (cotter pins) are sufficiently fastened.
- 3.7.8 Pull down on the Pendant and ensure that the Cord Strain Relief Cable takes the force, not the Pendant Cable.
- 3.7.9 **⚠ CAUTION** Check supply voltage before everyday use. If the voltage varies more than 10% of the rated value, electrical devices may not function normally.
- 3.7.10 Confirm proper operation.
- Before operating read and become familiar with **Section 4 - Operation**.
  - Before operating ensure that the hoist (and trolley) meets the Inspection, Testing and Maintenance requirements of ANSI/ASME B30.16.
  - Before operating ensure that nothing will interfere with the full range of the hoist's (and trolley's) operation.

## 4.0 Operation

### 4.1 Introduction

#### **DANGER**

DO **NOT** WALK UNDER A SUSPENDED LOAD

#### **WARNING**

HOIST OPERATORS SHALL BE REQUIRED TO READ THE OPERATION SECTION OF THIS MANUAL, THE WARNINGS CONTAINED IN THIS MANUAL, INSTRUCTION AND WARNING LABELS ON THE HOIST OR LIFTING SYSTEM, AND THE OPERATION SECTIONS OF ANSI/ASME B30.16 and ANSI/ASME B30.10. THE OPERATOR SHALL ALSO BE REQUIRED TO BE FAMILIAR WITH THE HOIST AND HOIST CONTROLS BEFORE BEING AUTHORIZED TO OPERATE THE HOIST OR LIFTING SYSTEM.

HOIST OPERATORS SHOULD BE TRAINED IN PROPER RIGGING PROCEDURES FOR THE ATTACHMENT OF LOADS TO THE HOIST HOOK.

HOIST OPERATORS SHOULD BE TRAINED TO BE AWARE OF POTENTIAL MALFUNCTIONS OF THE EQUIPMENT THAT REQUIRE ADJUSTMENT OR REPAIR, AND TO BE INSTRUCTED TO STOP OPERATION IF SUCH MALFUNCTIONS OCCUR, AND TO IMMEDIATELY ADVISE THEIR SUPERVISOR SO CORRECTIVE ACTION CAN BE TAKEN.

HOIST OPERATORS SHOULD HAVE NORMAL DEPTH PERCEPTION, FIELD OF VISION, REACTION TIME, MANUAL DEXTERITY, AND COORDINATION.

HOIST OPERATORS SHOULD **NOT** HAVE A HISTORY OF OR BE PRONE TO SEIZURES, LOSS OF PHYSICAL CONTROL, PHYSICAL DEFECTS, OR EMOTIONAL INSTABILITY THAT COULD RESULT IN ACTIONS OF THE OPERATOR BEING A HAZARD TO THE OPERATOR OR TO OTHERS.

HOIST OPERATORS SHOULD **NOT** OPERATE A HOIST OR LIFTING SYSTEM WHEN UNDER THE INFLUENCE OF ALCOHOL, DRUGS, OR MEDICATION.

OVERHEAD HOISTS ARE INTENDED ONLY FOR VERTICAL LIFTING SERVICE OF FREELY SUSPENDED UNGUIDED LOADS. DO **NOT** USE HOIST FOR LOADS THAT ARE NOT LIFTED VERTICALLY, LOADS THAT ARE NOT FREELY SUSPENDED, OR LOADS THAT ARE GUIDED.

#### **NOTICE**

- Read ANSI/ASME B30.16 and ANSI/ASME B30.10.
- Read the hoist manufacturer's Operating and Maintenance Instructions.
- Read all labels attached to equipment.



The operation of an overhead hoist involves more than activating the hoist's controls. Per the ANSI/ASME B30 standards, the use of an overhead hoist is subject to certain hazards that cannot be mitigated by engineered features, but only by the exercise of intelligence, care, common sense, and experience in anticipating the effects and results of activating the hoist's controls. Use this guidance in conjunction with other warnings, cautions, and notices in this manual to govern the operation and use of your overhead hoist.

## 4.2 Shall's and Shall Not's for Operation

### **WARNING**

Improper operation of a hoist can create a potentially hazardous situation which, if not avoided, could result in death or serious injury, and substantial property damage. To avoid such a potentially hazardous situation **THE OPERATOR SHALL:**

- **NOT** operate a damaged, malfunctioning or unusually performing hoist.
- **NOT** operate a hoist until you have thoroughly read and understood Manufacturer's Operating and Maintenance Instructions or Manuals.
- Be familiar with operating controls, procedures, and warnings.
- **NOT** operate a hoist that has been modified without the manufacturer's approval or without certification that it is in conformity with ANSI/ASME B30 volumes.
- **NOT** lift more than rated load for the hoist.
- **NOT** use hoist with twisted, kinked, damaged, or worn load chain.
- **NOT** use the hoist to lift, support, or transport people.
- **NOT** lift loads over people.
- **NOT** operate a hoist unless all persons are and remain clear of the supported load.
- **NOT** operate unless load is centered under hoist.
- **NOT** attempt to lengthen the load chain or repair damaged load chain.
- Protect the hoist's load chain from weld splatter or other damaging contaminants.
- **NOT** operate hoist when it is restricted from forming a straight line from hook to support in the direction of loading.
- **NOT** use load chain as a sling or wrap load chain around load.
- **NOT** apply the load to the tip of the hook or to the hook latch.
- **NOT** apply load unless the load chain is properly seated in its grooves.
- **NOT** apply load if bearing prevents equal loading on all load-supporting chain.
- **NOT** operate beyond the limits of the load chain travel.
- **NOT** leave load supported by the hoist unattended unless specific precautions have been taken.
- **NOT** allow the load chain or hook to be used as an electrical or welding ground.
- **NOT** allow the load chain or hook to be touched by a live welding electrode.
- **NOT** remove or obscure the warnings on the hoist.
- **NOT** operate a hoist on which the safety placards or decals are missing or illegible
- **NOT** operate a hoist unless it has been securely attached to a suitable support.
- **NOT** operate a hoist unless load slings or other approved single attachments are properly sized, and seated in the hook saddle.
- **NOT** use the hoist in such a way that could result in shock or impact loads being applied to the hoist.
- Take up slack carefully – make sure load is balanced and load-holding action is secure before continuing.
- Shut down a hoist that malfunctions or performs unusually and report such malfunction.
- Make sure hoist limit switches function properly.
- Warn personnel before lifting or moving a load.
- Warn personnel of an approaching load.

## CAUTION

Improper operation of a hoist can create a potentially hazardous situation which, if not avoided, could result in minor or moderate injury, or property damage. To avoid such a potentially hazardous situation

### THE OPERATOR SHALL:

- Maintain a firm footing or be otherwise secured when operating the hoist.
- Check brake function by tensioning the hoist prior to each lift operation.
- Use hook latches. Latches are to retain slings, chains, etc. under slack conditions only.
- Make sure the hook latches are closed and not supporting any parts of the load.
- Make sure the load is free to move and will clear all obstructions.
- Avoid swinging the load or hook.
- Make sure hook travel is in the same direction as shown on controls.
- Inspect the hoist regularly, replace damaged or worn parts, and keep appropriate records of maintenance.
- Use the hoist manufacturer's recommended parts when repairing the unit.
- Lubricate load chain per hoist manufacturer's recommendations.
- **NOT** use the hoist load limiting or warning device to measure load.
- **NOT** use limit switches as routine operating stops. They are emergency devices only.
- **NOT** allow your attention to be diverted from operating the hoist.
- **NOT** allow the hoist to be subjected to sharp contact with other hoists, structures, or objects through misuse.
- **NOT** adjust or repair the hoist unless qualified to perform such adjustments or repairs.

### 4.3 Hoist Controls

- 4.3.1 For hoists mounted to motorized trolleys follow the control instruction included in the trolley's Owner's Manual.
- 4.3.2 Emergency Stop Button – Press the Emergency Stop Button to perform an emergency stop and lock-out of hoist motion controls or to reset the VFD as shown in Figure 4-1. Turn the Emergency Stop Button clockwise to unlock the controls and allow hoist operation. “Hbb” will appear on the unit's VFD display when the Emergency Stop Button is depressed.
- 4.3.3 Pendant Control – Pendant controls supplied with hoist have two step control buttons. For low speed, depress the button to the first step and for high speed, depress the button fully to the second step. Use the UP button to raise the hoist load chain/hook or the DOWN button to lower the hoist load chain/hook as shown in Figure 4-1. To stop motion release the buttons.
- 4.3.4 **CAUTION** Make sure the motor completely stops before reversing direction.

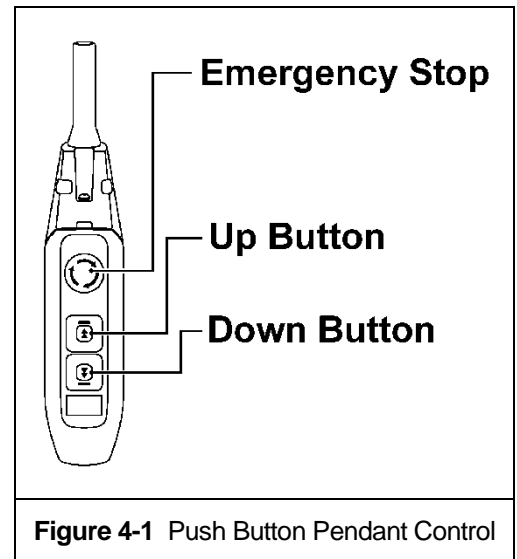

Figure 4-1 Push Button Pendant Control

## 5.0 Inspection

### 5.1 General

- 5.1.1 The inspection procedure herein is based on ANSI/ASME B30.16. The following definitions are from ANSI/ASME B30.16 and pertain to the inspection procedure below.
- **Designated Person** – a person selected or assigned as being competent to perform the specific duties to which he/she is assigned.
  - **Qualified Person** – a person who, by possession of a recognized degree or certificate of professional standing, or who, by extensive knowledge, training, and experience, has successfully demonstrated the ability to solve or resolve problems relating to the subject matter and work.
  - **Normal Service** – that distributed service which involves operation with randomly distributed loads within the rated load limit, or uniform loads less than 65% of rated load for not more than 25% of the time.
  - **Heavy Service** – that service which involves operation within the rated load limit which exceeds normal service.
  - **Severe Service** – that service which involves normal or heavy service with abnormal operating conditions.

### 5.2 Inspection Classification

- 5.2.1 Initial Inspection – prior to initial use, all new, altered, or modified hoists shall be inspected by a designated person to ensure compliance with the applicable provisions of this manual.
- 5.2.2 Inspection Classification – the inspection procedure for hoists in regular service is divided into two general classifications based upon the intervals at which inspection should be performed. The intervals in turn are dependent upon the nature of the critical components of the hoist and the degree of their exposure to wear, deterioration, or malfunction. The two general classifications are herein designated as FREQUENT and PERIODIC, with respective intervals between inspections as defined below.
- 5.2.3 FREQUENT Inspection – visual examinations by the operator or other designated personnel with intervals per the following criteria:
- Normal service – monthly
  - Heavy service – weekly to monthly
  - Severe service – daily to weekly
  - Special or infrequent service – as recommended by a qualified person before and after each occurrence.
- 5.2.4 PERIODIC Inspection – visual inspection by a designated person with intervals per the following criteria:
- Normal service – yearly
  - Heavy service – semiannually
  - Severe service – quarterly
  - Special or infrequent service – as recommended by a qualified person before the first such occurrence and as directed by the qualified person for any subsequent occurrences.

### 5.3 Frequent Inspection

- 5.3.1 Inspections should be made on a FREQUENT basis in accordance with **Table 5-1**, “Frequent Inspection.” Included in these FREQUENT Inspections are observations made during operation for any defects or damage that might appear between Periodic Inspections. Evaluation and resolution of the results of FREQUENT Inspections shall be made by a designated person such that the hoist is maintained in safe working condition.

<b>Table 5-1</b> Frequent Inspection
All functional operating mechanisms for maladjustment and unusual sounds.
Operation of limit switch and associated components
Hoist braking system for proper operation
Hooks in accordance with ANSI/ASME B30.10
Hook latch operation
Load chain in accordance with <b>Section 5.7</b>
Load chain reeving for compliance with <b>Section 3.2</b> and <b>6.5</b>

### 5.4 Periodic Inspection

- 5.4.1 Inspections should be made on a PERIODIC basis in accordance with **Table 5-2**, “Periodic Inspection.” Evaluation and resolution of the results of PERIODIC Inspections shall be made by a designated person such that the hoist is maintained in safe working condition.
- 5.4.2 For inspections where load suspension parts of the hoist are disassembled, a load test per ANSI/ASME B30.16 must be performed on the hoist after it is re-assembled and prior to its return to service.

<b>Table 5-2</b> Periodic Inspection
Requirements of frequent inspection.
Evidence of loose bolts, nuts, or rivets.
Evidence of worn, corroded, cracked, or distorted parts such as load blocks, suspension housing, chain attachments, clevises, yokes, suspension bolts, shafts, gears, bearings, pins and rollers.
Evidence of damage to hook retaining nuts or collars and pins, and welds or rivets used to secure the retaining members.
Evidence of damage or excessive wear of load and idler sheaves.
Evidence of excessive wear on motor or load brake.
Electrical apparatus for signs of pitting or any deterioration of visible controller contacts.
Evidence of damage of supporting structure or trolley, if used.
Function labels on pendant control stations for legibility.
Warning label properly attached to the hoist and legible (see <b>Section 1.2</b> ).
End connections of load chain.

## 5.5 Occasionally Used Hoists

- 5.5.1 Hoists that are used infrequently shall be inspected as follows prior to placing in service:
- Hoist Idle More Than 1 Month, Less Than 1 Year: Inspect per FREQUENT Inspection criteria in **Section 5.3**.
  - Hoist Idle More Than 1 Year: Inspect per PERIODIC Inspection criteria in **Section 5.4**.

## 5.6 Inspection Records

- 5.6.1 Dated inspection reports and records should be maintained at time intervals corresponding to those that apply for the hoist's PERIODIC interval per **Section 5.2.4**. These records should be stored where they are available to personnel involved with the inspection, maintenance, or operation of the hoist.
- 5.6.2 A long range chain inspection program should be established and should include records of examination of chains removed from service so a relationship can be established between visual observation and actual condition of the chain.

## 5.7 Inspection Methods and Criteria

- 5.7.1 This section covers the inspection of specific items. The list of items in this section is based on those listed in ANSI/ASME B30.16 for the Frequent and Periodic Inspection. In accordance with ANSI/ASME B30.16, these inspections are not intended to involve disassembly of the hoist. Rather, disassembly for further inspection would be required if frequent or periodic inspection results so indicate. Such disassembly and further inspection should only be performed by a qualified person trained in the disassembly and re-assembly of the hoist.

Item	Method	Criteria	Action
Functional operating mechanisms.	Visual, Auditory	Mechanisms should be properly adjusted and should not produce unusual sounds when operated.	Repair or replace as required.
Limit Switches (upper and lower)	Function	Proper operation. Actuation of limit switch should stop hoist.	Repair or replace as required.
Limit Lever Assembly	Visual, Function	Lever should not be bent or significantly worn and should be able to move freely.	Replace.
Braking System Operation	Function	Braking distance with rated capacity should not exceed 3% of the lifting speed (approximately two chain links).	Repair or replace as required.
Hooks/Suspension Bar - Surface Condition	Visual	Should be free of significant rust, weld splatter, deep nicks, or gouges.	Replace.
Hooks - Fretting wear	Measure	The "u" and "t" dimensions should not be less than discard value listed in <b>Table 5-4</b> .	Replace.
Hooks - Stretch	Measure	The "k" dimension should not be greater than 1.05 times that measured and recorded at the time of purchase (See <b>Section 3.7</b> ). If recorded "k" values are not available for hooks when new, use nominal "k" values from <b>Table 5-4</b> .	Replace.
Hooks - Bent Shank or Neck	Visual	Shank and neck portions of hook should be free of deformations.	Replace.

<b>Table 5-3 Hoist Inspection Methods and Criteria</b>			
<b>Item</b>	<b>Method</b>	<b>Criteria</b>	<b>Action</b>
Hooks - Swivel Bearing	Visual, Function	Bearing parts and surfaces should not show significant wear, and should be free of dirt, grime and deformations. Hook should rotate freely with no roughness.	Clean/lubricate, or replace as required.
Hooks - Yoke Assembly	Visual	Should be free of significant rust, weld splatter, nicks, and gouges. Holes should not be elongated. Fasteners should not be loose, and there should be no gap between mating parts.	Measure, tighten, or replace as required.
Suspension Bar - Wear	Measure	The "d" and "e" dimension should not be less than 0.95 times that measured and recorded at the time of purchase (See <b>Section 3.7</b> ). If recorded "d" and "e" values are not available for suspension bar when new, use nominal "d" and "e" values from <b>Table 5-5</b> .	Replace.
Hooks - Hook Latches	Visual, Function	Latch should not be deformed. Attachment of latch to hook should not be loose. Latch spring should not be missing and should not be weak. Latch movement should not be stiff - when depressed and released latch should snap smartly to its closed position.	Replace.
Load Chain - Surface Condition	Visual	Should be free of rust, nicks, gouges, dents and weld splatter. Links should not be deformed, and should not show signs of abrasion. Surfaces where links bear on one another should be free of significant wear.	Replace.
Load Chain - Pitch and Wire Diameter	Measure	The "P" dimension should not be greater than maximum value listed in <b>Table 5-6</b> . The "d" dimension should not be less than minimum value listed in <b>Table 5-6</b> .	Replace. Inspect Load Sheave.
Load Chain - Lubrication	Visual, Auditory	Entire surface of each chain link should be coated with lubricant and should be free of dirt and grime. Chain should not emit cracking noise when hoisting a load.	Clean/lubricate (see <b>Section 6.0</b> ).
Load Chain - Reeving	Visual	Chain should be reeved properly through Load Sheave - refer to <b>Section 6.5</b> . Chain, Chain Springs, Cushion Rubbers, Striker Plates, and Stoppers should be installed properly - refer to <b>Section 3.2</b> .	Reeve/Install chain properly.
Cushion Rubber	Visual	Should be free of significant deformation.	Replace.
Chain Springs	Visual	Chain springs should not be deformed or compressed. Refer to <b>Table 5-9</b> for Chain Spring dimensions.	Replace.
Chain Guide	Visual	Chain Guide should be free of significant wear. Chain Guide surfaces should be free of deformation by nicks, gouges, and abrasion. Refer to <b>Figure 5-1</b> .	Replace.

<b>Table 5-3 Hoist Inspection Methods and Criteria</b>			
<b>Item</b>	<b>Method</b>	<b>Criteria</b>	<b>Action</b>
Chain Container	Visual	Container should not be damaged. Brackets should not be deformed or missing.	Replace.
Housing and Mechanical Components	Visual, Auditory, Vibration, Function	Hoist components including load blocks, suspension housing, chain attachments, clevises, yokes, suspension bolts, shafts, gears, bearings, pins and rollers should be free of cracks, distortion, significant wear and corrosion. Evidence of same can be detected visually or via detection of unusual sounds or vibration during operation.	Replace.
Bolts, Nuts and Rivets	Visual, Check with Proper Tool	Bolts, nuts and rivets should not be loose.	Tighten or replace as required.
Brake Assembly	Measure, Visual	The motor brake gap is directly related to brake wear. As the brake pad wears, the brake dimension "B" will change. Depending on hoist model, the brake gap/wear dimension should not exceed or be less than discard value listed in <b>Table 5-7</b> . Bolts and screws should not be loose.	Tighten bolts and screws as required or replace Brake Assembly. <u>Note</u> : DO NOT attempt to adjust or disassemble the Brake Assembly.
VFD	Visual, Function	There should be no fault codes (Reference <b>Section 3.6</b> .)	Replace as needed.
DPC - fasteners	Visual	Make sure that the 8 installation screws for fastening the DPC heat sink to the base plate and the 2 screws fastening the DPC to hoist body are not loose. Check the electrical components on the DPC to make sure the screws are not loose and that the wiring is properly connected.	Tighten screws.
DPC – heat sink	Visual	Remove the DPC and place it on a flat surface to make sure that the heat sink is not bent.	Replace the DPC.
Load Sheave	Visual	Pockets of Load Sheave should be free of significant wear. Refer to <b>Table 5-8</b> for Load Sheave wear dimensions.	Replace.
Pendant - Housing	Visual	Pendant housing should be free of cracks and mating surfaces of parts should seal without gaps.	Replace.
Pendant - Wiring	Visual	Wire connections to switches in pendant should not be loose or damaged.	Tighten or repair
Pendant - Switches	Function	Depressing and releasing push-buttons should make and break contacts in switch contact block and result in corresponding electrical continuity or open circuit. Push-buttons should be interlocked either mechanically or electrically to prevent simultaneous energization of circuits for opposing motions (e.g. up and down).	Repair or replace as necessary.



Pendant - Cord	Visual, Electrical Continuity	Surface of cord should be free from nicks, gouges, and abrasions. Each conductor in cord should have 100% electrical continuity even when cord is flexed back-and-forth. Pendant Cord Strain Relief Cable should absorb the entire load associated with forces applied to the pendant.	Replace.
Pendant - Labels	Visual	Labels denoting functions should be legible.	Replace.
Warning Labels	Visual	Warning Labels should be affixed to the hoist (see <b>Section 1.2</b> ) and they should be legible.	Replace.
Hoist Capacity Label	Visual	The label that indicates the capacity of the hoist should be legible and securely attached to the hoist.	Replace.
Nameplates	Visual	The nameplates that indicate the hoist model, speed and motor data should be legible and securely attached to the hoist.	Replace.

Table 5-4 Top Hook & Bottom Hook Dimensions					
<p>"k" Measured When New:</p> <p>Top: _____</p> <p>Bottom: _____</p>					
Capacity Code	Nominal "k" Dimension* inch (mm)	"u" Dimension inch (mm)		"t" Dimension inch (mm)	
		Standard	Discard	Standard	Discard
001SD, 003SD, 005SD	1.77 (45.0)	0.93 (23.5)	0.88 (22.3)	0.69 (17.5)	0.65 (16.6)
010SD	1.97 (50.0)	1.22 (31.0)	1.16 (29.5)	0.89 (22.5)	0.84 (21.4)

\*These values are nominal since the dimension is not controlled to a tolerance. The "k" dimension should be measured when the hook is new - this becomes a reference measurement. Subsequent measurements are compared to this reference measurement in order to determine hook deformation/stretch. See Table 5-3, "Hooks - Stretch".

**Table 5-5 Suspension Bar Dimensions**

"d" and "e" Measured When New:

d: \_\_\_\_\_

e: \_\_\_\_\_

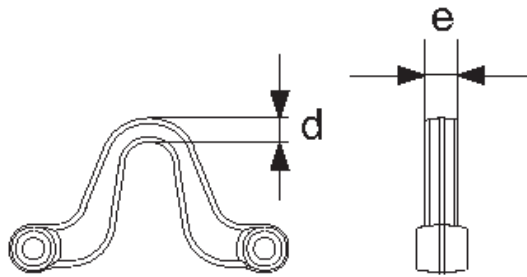

Capacity Code	"d" Dimension inch (mm)		"e" Dimension inch (mm)	
	Standard	Discard	Standard	Discard
001SD, 003SD, 005SD	0.31 (8.0)	0.30 (7.6)	0.63 (16.0)	0.60 (15.2)
010SD	0.48 (12.3)	0.46 (11.7)	0.87 (22.0)	0.82 (20.9)

**Table 5-6 Chain Wear Dimensions**

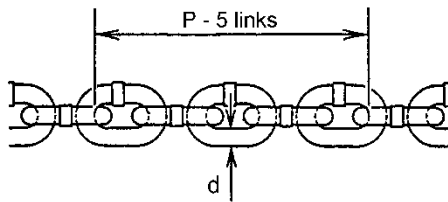

Capacity Code	"P" Dimension inch (mm)		"d" Dimension inch (mm)	
	Standard	Discard	Standard	Discard
001SD, 003SD, 005SD	3.11 (79)	3.21 (81.5)	0.22 (5.6)	0.20 (5.1)
010SD	3.94 (100)	4.06 (103)	0.28 (7.1)	0.25 (6.4)

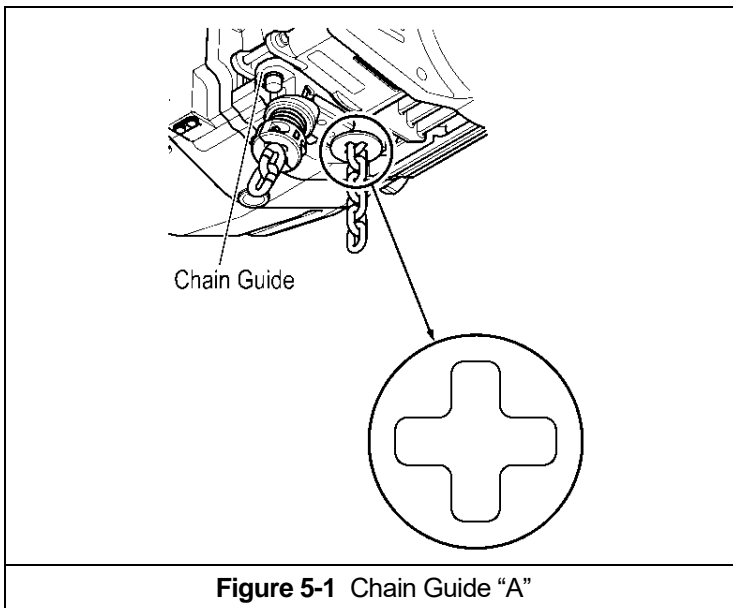
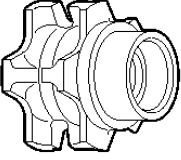
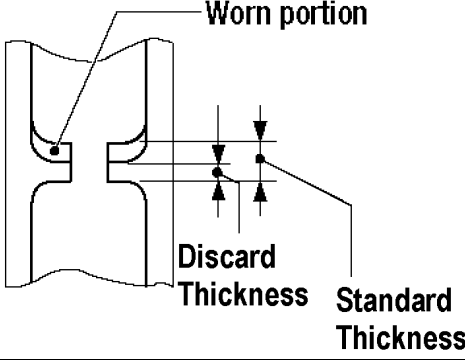

**Table 5-7** Motor Brake Wear/Gap Dimensions

**001SD, 003SD, 005SD**

**010SD**

Capacity Code	"B" Dimension - inch (mm)		Criteria
	Standard	Discard	
001SD, 003SD, 005SD	0.12 (3.0)	0.14(3.5)	Not to exceed
010SD	0.16 (4.0)	0.14 (3.5)	Not to fall below

<b>Table 5-8</b> Load and Idle Sheave Wear Dimensions		
 <p><b>Load Sheave</b></p>		
Capacity Code	"Thickness" - inch (mm)	
	Standard	Discard
001SD, 003SD, 005SD	0.13 (3.4)	0.09 (2.3)
010SD	0.20 (5.0)	0.13 (3.3)

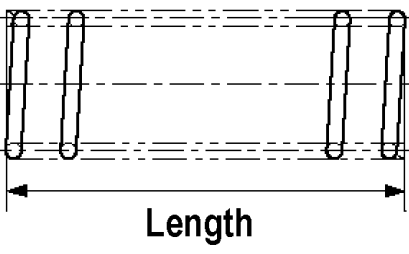
<b>Table 5-9</b> Chain Spring Length Dimensions		
		
Capacity Code	"Length" - inch (mm)	
	Standard	Discard
005SD	1.14 (29)	1.04 (26.5)
010SD	1.04 (26.5)	0.94 (24)

## 6.0 Maintenance and Handling

### 6.1 Count/Hour Meter

















A count/hour function is included in all SEQ hoists as one of the VFD parameters. Below are maintenance recommendations based on the number of starts and hours of operation accessed through the VFD.

6.1.1 Number of Starts/Hours of operation -. Refer to **Table 6-1** for parameter identification. Refer to **Table 6-2** for Count/Hour access procedure.

Parameter	Name	Description
U7-01	Number of Starts (Higher Order)	The number of starts in the <b>up and down</b> direction x 1,000. Up to 10,000 units are displayed. Display of "1" = 1,000 starts. Display of "10,000" = 10,000,000 starts
U7-02	Number of Starts (Lower Order)	The number of starts in the <b>up and down</b> direction under 1,000 starts (1 to 999). One start will register a "1" in the display. When 1,000 starts are reached, the value of U7-01 is incremented by 1 and the value of U7-02 is reset to 0.
U7-03	Hours of Operation	The number of hours of operation in the <b>up and down</b> directions. One hour will register a "1" in the display. Up to 65535 hours are displayed.

For example using **Table 6-1**:

- If U7-01 displays "81", U7-02 displays "567", U7-03 displays "122"
- The Number of Starts = 81,567
- The Number of Operated Hours = 122

Operational Step	VFD Display
1. Energize the hoist.	
2. Press  until the "Monitor" screen is displayed (blinking).	
3. Press  to display the parameter setting screen and then press  to move from "01" to "U1".	
4. Press  or  until the display reads "U7" (left value blinking).	
5. Press  and  or  to select the specific "Monitor" parameter (right value blinking). (Example: U7-03 –Hours of Operation)	
6. Press  to display the current parameter value. (Example: 75 Hours)	
7. Press  until the display returns to the initial screen. (As in Step 1.)	

6.1.2 Gear Oil – The C/H Meter can be used in conjunction with the average load lifted by the hoist to estimate when the gear oil should be changed. Refer to **Table 6-3**.

<b>Table 6-3</b> Criteria for Recommended Gear Oil Replacement		
<b>Loading During Normal Operation</b>		<b>Change Gear Oil After: (hours)</b>
<b>Rating</b>	<b>Average % of Rated Capacity</b>	
Light	0 to 33%	360
Medium	33 to 67%	240
Heavy	67 to 100%	120

6.1.3 Brake – The C/H Meter can be used to determine when the Brake should be monitored or replaced. Refer to **Table 6-4**.

- When 1 Million starts have been achieved, inspect brake gap referring to **Table 6-4** criteria.
- When 2 Million starts have been achieved, replace brake drum, motor cover, brake spring and pull rotor regardless of brake gap.

<b>Table 6-4</b> Criteria for Brake Replacement	
<b>Condition of Electromagnetic Brake Gap (Ref. Table 5-7 for Gap Wear Dimension)</b>	<b>Action</b>
Brake gap is less than 50% of the limit.	Check the Brake at every 200,000 starts.
Brake gap reaches 50 to 100% of the limit.	Check the Brake at every 100,000 starts until the brake gap reaches the limit gap.
Brake gap reaches the limit.	Replace the brake drum, motor cover, brake spring and pull rotor spring.

6.1.4 Hook and Yoke – The C/H Meter can be used to determine when the Top/Bottom Hook and Yoke should be replaced. Refer to **Table 6-5**.

<b>Table 6-5</b> Criteria for Top/Bottom Hook and Yoke Replacement	
<b>Rate of Loading</b>	<b>Number of Starts to replace Hook and Yoke</b>
Light - The hoist is mostly used with a light load. Rated capacity rarely applied.	Every 2 million starts.
Medium – The hoist is mostly used with a medium load. Rated capacity frequently applied.	Every 1.5 million starts.
Heavy – The hoist is mostly used with a heavy load. Rated capacity frequently applied.	Every 1 million starts.
Ultra-Heavy – Rated capacity constantly applied.	Every 1 million starts.

6.1.5 You are encouraged to use the Count/Hour Meter in conjunction with your experience with the hoist's application and usage to develop a history upon which to gage and fine tune your maintenance program for the hoist.

## 6.2 Lubrication – Load Chain, Hooks and Suspension

### 6.2.1 Load Chain

- For longer life, the load chain should be lubricated.
- The load chain lubrication should be accomplished after cleaning the load chain with an acid free cleaning solution.

- Apply KITO lubricating grease (Part No. ER2CS1951) or an equivalent to industrial general lithium grease, NLGI No. 0, to the bearing surfaces of the load chain links as indicated by the shaded areas in **Figure 6-1**. Also apply the grease to the areas of the load chain (shaded areas in **Figure 6-1**) that contact the load sheave. Ensure that the grease is applied to the contact areas in the load sheave pockets.
- Machine or gear oil (grade ISO VG 46 or 68 oil or equivalent) may be used as an alternative lubricant but must be applied more frequently.

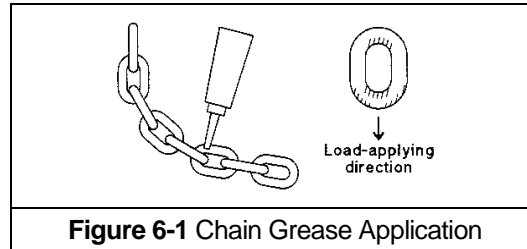

**Figure 6-1** Chain Grease Application

- The chain should be lubricated every 3 months (more frequently for heavier usage or severe conditions).
- For dusty environments, it is acceptable to substitute a dry lubricant.

#### 6.2.2 Hooks and Suspension Components:

- Hooks - Bearings should be cleaned and lubricated at least once per year for normal usage. Clean and lubricate more frequently for heavier usage or severe conditions.
- Suspension Pins - Lubricate at least twice per year for normal usage; more frequently for heavier usage or severe conditions.

### 6.3 Lubrication - Gearbox

- 6.3.1 **⚠ WARNING** Using an incorrect type/grade of gearbox oil or the wrong quantity of oil may prevent the friction clutch from working properly and may affect the ability of the hoist to hold the load. DO NOT use any oil or quantity other than that listed below. New hoists are prefilled with the correct type and amount of oil.
- 6.3.2 **DETERMINING OIL LIFE** - Refer to **Section 6.1.3** when estimating gear oil life based on operations.
- 6.3.3 **OIL LEVEL** – Check the oil level by removing the oil plug as shown in **Figure 6-2**. Insert a dip stick to check the oil from the oil check hole. Reference **Figure 6-3** and **Table 6-6** for check distances between the hole and the oil level.

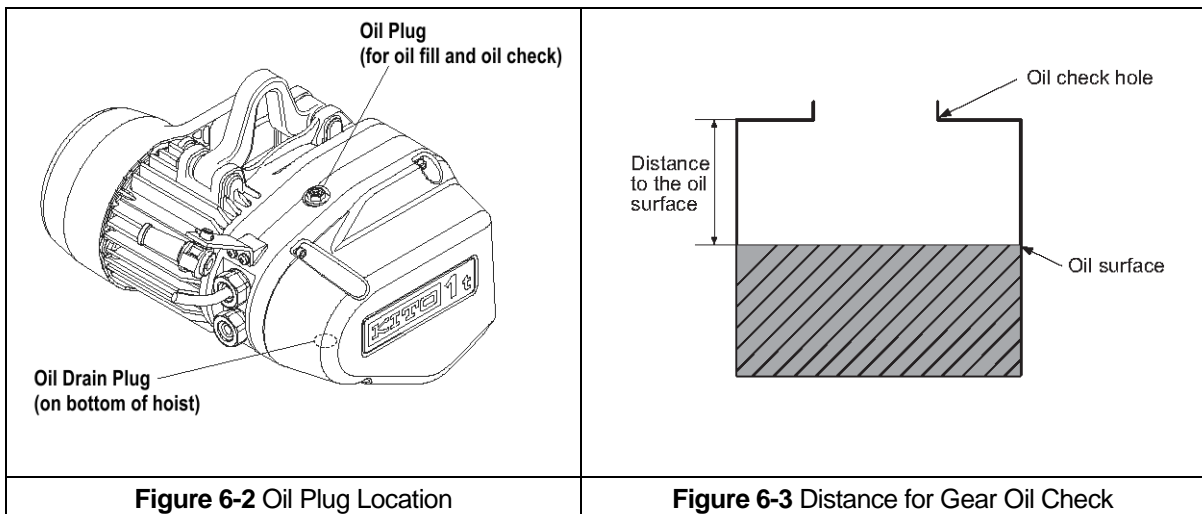

6.3.4

Capacity Code	Check Distance (inches)	Check Distance (millimeters)
001SD, 003SD, 005SD	4.21-4.37	107-111
010SD	3.98-4.13	101-105

6.3.5 **REPLACING OIL** – Change gear oil at least once every 5 years. The oil should be changed more frequently depending on the hoist's usage and operating environment. Refer to **Section 6.1.3**. Follow the procedure below for replacing the gearbox oil for your hoist:

- To drain the current oil from the hoist remove “Oil Plug” on top of the hoist and the “Oil Drain plug” on the bottom of the hoist. Allow the old oil to drain completely. Refer to **Figure 6-2** for oil plug locations.
- **NOTICE** Dispose of the used oil in accordance with local regulations.
- Refill the gear case with the correct quantity and type of new oil or until the oil level is within the range shown in Table 6-6. Refer to Figure 6-3.
- Ensure that the oil plug is reinstalled and secured into the hoist body.

Capacity Code	Litres	Quarts
001SD, 003SD, 005SD	0.51	0.54
010SD	0.84	0.89

- **WARNING** Using an incorrect type/grade of gearbox oil or the wrong quantity of oil may prevent the friction clutch from working properly and may affect the ability of the hoist to hold the load. Refer to the following for correct types/grades of gearbox oil:

**Gear Oil:**

- KITO standard: Bonnoc M260 (NIPPON OIL);
- Part Numbers:
  - ER1BS1855 – 0.7 Litre
  - ER1CS1855 – 1.0 Litre

## 6.4 Motor Brake

6.4.1.1 The motor brake is not adjustable.

6.4.1.2 Refer to **Section 5.7** and **Table 5-7** for Brake Gap/Wear criteria.



## 6.5 Load Chain

6.5.1 Lubrication and Cleaning – refer to **Section 6.2**.

6.5.2 Load Chain Replacement:

- 1) **⚠ CAUTION** The hoist must be properly powered and operational in order to perform the following procedures.
- 2) **⚠ WARNING** Be certain that the replacement chain is obtained from KITO and is the exact size, grade and construction as the original chain. The new load chain must have an odd number of links so that both its end links have the same orientation. If the load chain is being replaced due to damage or wear, destroy the old chain to prevent its reuse.
- 3) **⚠ CAUTION** When replacing load chain, check for wear on mating parts, i.e. Load Sheave and Chain Guides, replace parts if necessary. Remove all chain components including the Bottom Hook Set Assembly, Stoppers, Cushion Rubbers, Chain Springs and Striker Plates, from the chain for reuse on new chain. Inspect and replace any damaged or worn parts.
- 4) Using a C-link, attach the new chain to the end link of the old chain on the no-load side. The end link of the new load chain should be connected so that the welded portions of the load chain's standing links are oriented to the outside as they pass over the sheave. Refer to **Figure 6-2**.
- 5) Operate the hoist up to move the chain through the hoist body. Stop when a sufficient amount of new chain is accumulated on the load side.
- 6) Attach the chain components (step 4 above) to the chain. Refer to **Section 3.2** for the proper locations.
- 7) **⚠ WARNING** Make sure Stoppers, Cushion Rubbers, Chain Springs and Striker Plates are properly installed. Refer to **Section 3.2**.
- 8) After installation has been completed, perform steps outlined in **Section 3.7**, "Preoperational Checks and Trial Operation".

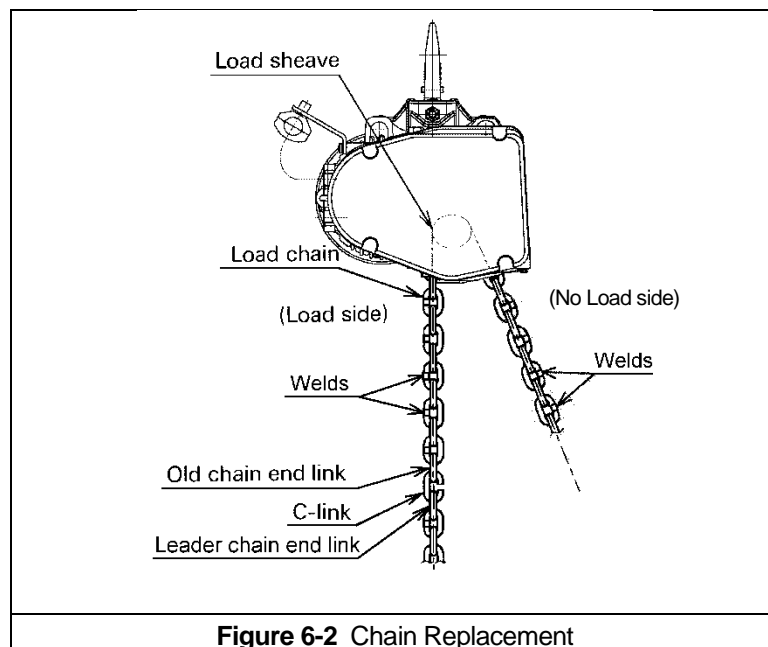

**Figure 6-2** Chain Replacement

## 6.6 Friction Clutch

- 6.6.1 If abnormal operation or slippage occurs do NOT attempt to disassemble or adjust the Friction Clutch. Replace the worn or malfunctioning Friction Clutch as an assembly with a new, factory adjusted part.

## 6.7 Storage

- 6.7.1 The storage location should be clean and dry.

## 6.8 Outdoor Installation

- 6.8.1 For hoist installations that are outdoors, the hoist MUST BE covered and protected from the weather at all times.
- 6.8.2 Possibility of corrosion on components of the hoist increases for installations where salt air and high humidity are present. The hoist may require more frequent lubrication. Make frequent and regular inspections of the unit's condition and operation.
- 6.8.3 For hoist installations where temperature variations introduce condensation into the hoist, additional inspection and more frequent lubrication may be required.
- 6.8.4 Refer to **Section 2.1.3** for allowable environmental conditions.

## 6.9 Operational Environment

- 6.9.1 Non-conforming environment

A non-conforming environment is defined as one with any or all of the following.

- Explosive gases or vapor
- Organic solvents or volatile powder
- Excessive amounts of powder and dust of general substances
- Excessive amount of acids or salts.

## 7.0 Troubleshooting

### **WARNING**

**HAZARDOUS VOLTAGES ARE PRESENT IN THE HOIST AND IN CONNECTIONS BETWEEN COMPONENTS.**

Before performing ANY maintenance on the equipment, de-energize the supply of electricity to the equipment, and lock and tag the supply device in the de-energized position. Refer to ANSI Z244.1, "Personnel Protection – Lockout/Tagout of Energy Sources."

To avoid a shock hazard, **DO NOT** perform **ANY** mechanical or electrical maintenance on the dual speed (or VFD control) hoist within 5 minutes of de-energizing (disconnecting) the trolley or hoist. This time allows the internal VFD capacitor to safely discharge.

Only trained and competent personnel should inspect and repair this equipment.

Do Not perform "withstand voltage" test or "insulation resistance" measurement (megger) with the VFD connected.

Do Not remove power to the hoist or trolley during operation.

Do Not connect power to the output of the VFD.

When handling VFD provide ESD protection.

**Table 7-1 Troubleshooting Guide**

Symptom	Cause	Remedy
Hoist moving in wrong direction	Improper electrical connections	Refer to wiring diagram and check all connections.
Hoist will not operate	Loss of power	Check circuit breakers, switches, fuses, and connections on power lines/cable.
	Wrong voltage or frequency	Check voltage and frequency of power supply against the rating on the nameplate of the motor.
	Hoist overloaded	Reduce load to within rated capacity of hoist.
	Motor overheated and thermal overload protector has tripped	See Trouble Shooting Problem "Motor or brake overheating".
	Improper, loose, or broken wire in hoist electrical system	Shut off power supply, check wiring connections on hoist control panel and inside push-button pendant.
Brake does not release	Check motor brake adjustment for proper clearance. Replace brake if needed.	

**Table 7-1 Troubleshooting Guide**

<b>Symptom</b>	<b>Cause</b>	<b>Remedy</b>
Hoist will not operate (continued)	Faulty VFD	Check fault codes (Reference <b>Section 3.6</b> ). Reset VFD by pressing the Emergency Stop Button on pendant. Replace as needed.
	Faulty Interface Board	Replace Interface Board.
	Emergency Stop Depressed on Push Button Pendant Control	“Hbb” will appear on the dual speed unit’s VFD display when the Emergency Stop Button is depressed. Turn the Emergency Stop Button clockwise to unlock the controls and allow hoist operation.
	Motor burned out	Replace motor frame/stator, shaft/rotor, and any other damaged parts.
Hoist lifts but will not lower	Down circuit open	Check circuit for loose connections. Check down side of limit switch for malfunction.
	Broken conductor in pendant cord	Check the continuity for each conductor in the cable. If one is broken, replace entire cable.
	Faulty VFD	Check fault codes (Reference <b>Section 3.6</b> ). Reset VFD by pressing Emergency Stop Button on pendant. Replace as needed.
	Faulty switch in pendant	Check electrical continuity. Check electrical connections. Replace or repair as needed.
Hoist lowers but will not lift	Hoist overloaded	Reduce load to within rated capacity of hoist.
	Low voltage in hoist's power supply	Determine cause of low voltage and bring to within plus or minus 10% of the voltage specified on the motor nameplate.
	Up circuit open	Check circuit for loose connections. Check up side of limit switch for malfunction.
	Broken conductor in pendant cord	Check the continuity of each conductor in the cable. If one is broken, replace entire cable.
	Faulty VFD	Check fault codes (Reference <b>Section 3.6</b> ). Reset VFD by pressing Emergency Stop Button on pendant. Replace as needed.
	Faulty switch in pendant	Check electrical continuity. Check electrical connections. Replace or repair as needed.
	Faulty friction clutch	Replace.

**Table 7-1 Troubleshooting Guide**

<b>Symptom</b>	<b>Cause</b>	<b>Remedy</b>
Hoist will not lift rated load or does not have the proper lifting speed	Hoist overloaded	Reduce load to within rated capacity.
	Low voltage in hoist's power supply	Determine cause of low voltage and bring to within plus or minus 10% of voltage specified on the motor nameplate.
	Brake drags/chatters	Check motor brake adjustment for proper clearance. Replace brake if needed. Check VFD for fault codes
	Faulty friction clutch	Replace.
	Faulty VFD	Check fault codes (Reference <b>Section 3.6</b> ). Reset VFD by pressing Emergency Stop Button on pendant. Replace as needed.
Load drifts excessively when hoist is stopped	Motor brake not holding	Check brake for proper "Brake Gap" dimension. (Reference <b>Table 5-7</b> ). Replace if needed.
	Faulty VFD	Check fault codes (Reference <b>Section 3.6</b> ). Reset VFD by pressing Emergency Stop Button on pendant. Replace as needed.
Motor or brake overheating	Excessive load	Reduce load to within rated capacity of hoist.
	Excessive duty cycle	Reduce frequency of lifts.
	Wrong voltage or frequency	Check voltage and frequency of power supply against the rating on the nameplate on the motor.
	Brake drags/chatters	Check VFD for fault codes. Replace VFD.
	Extreme external heating	Above an ambient temperature of 60°C, the frequency of hoist operation must be reduced to avoid overheating of the motor. Special provisions should be made to ventilate the hoist or otherwise shield it from the heat.
Hoist operates intermittently	Collectors making poor contact	Check movement of spring loaded arm, weak spring, connections, and shoe. Replace as needed.
	Contactors contacts arcing	Check for burned contacts. Replace as needed.
	Loose connection in circuit	Check all wires and terminals for bad connections. Replace as needed.
	Broken conductor in Pendant Cord	Check for intermittent continuity in each conductor the Pendant Cord. Replace entire Pendant Cord if continuity is not constant.
	Faulty VFD	Check fault codes (Reference <b>Section 3.6</b> ). Reset VFD by pressing Emergency Stop Button on pendant. Replace as needed.

## **8.0 Warranty**

All products sold by KITO Canada Inc. are warranted to be free from defects in material and workmanship from date of purchase for the following periods:

**1 year – Hoists, Trolleys and Parts**

**3 years – ER2, EQ and SEQ Model Hoists**

**5 years – EQ, SEQ and TNER Motor Brake**

**10 years – ER2 Motor Brake**

The product must be used in accordance with manufacturer's recommendations and must not have been subject to abuse, lack of maintenance, misuse, negligence, or unauthorized repairs or alterations.

Should any defect in material or workmanship occur during the above time period in any product, as determined by KITO Canada's inspection of the product, KITO Canada agrees, at its discretion, either to replace (not including installation) or repair the part or product free of charge and deliver said item F.O.B. KITO Canada Inc. place of business to customer.

Customer must obtain a Return Goods Authorization (RGA) as directed by KITO Canada Inc. prior to shipping product for warranty evaluation. An explanation of the complaint must accompany the product. Product must be returned freight prepaid. Upon repair, the product will be covered for the remainder of the original warranty period. Replacement parts installed after the original warranty period will only be eligible for replacement (not including installation) for a period of one year from the installation date. If it is determined there is no defect, or that the defect resulted from causes not within the scope of KITO Canada's warranty, the customer will be responsible for the costs of returning the product.

KITO Canada Inc. disclaims any and all other warranties of any kind expressed or implied as to the product's merchantability or fitness for a particular application. KITO Canada will not be liable for death, injuries to persons or property or for incidental, contingent, special or consequential damages, loss or expense arising in connection with the use or inability whatsoever, regardless of whether damage, loss or expense results from any act or failure to act by KITO Canada, whether negligent or willful, or from any other reason.

## 9.0 Parts List

When ordering Parts, please provide the Hoist code number, lot number and serial number located on the Hoist nameplate (see fig. below).

Reminder: Per sections 1.1 and 3.7.4 to aid in ordering Parts and Product Support, record the Hoist code number, lot number and serial number in the space provided on the cover of this manual.

Hz	V	HP	A

Electric Chain Hoist  
LR39366

Made in Japan/Producto hecho en Japón/Fabriqué au Japon  
Harrington Hoists, Inc. Manheim, PA17545

Electrical Safety Only

· Code/ Código / Code:

· Chain Size / Tamaño de cadena /  
Taille de la chaîne:  mm

· Duty Class/Clase de trabajo/Classe de service:

· Lifting Speed / Velocidad de elevación /  
Vitesse de levage:  ft/min  
 m/min

· 1Phase Input/1Fase de entrada/Courant monophasé  
Hoist/ Grúa/ Appareil de levage

Type	V	HP	A	rpm	%D.C/h

· Lot No. / N.º de lote / N.º de lot:

· Serial No./N.º de serie/N.º de série:

· Motor Spec./Especificación del motor/Spéc. moteur  
· Phase / Fase / Phase: 3  
IP55, 4P, 60Hz  
Hoist/ Grúa/ Appareil de levage

NY FID:H1

The parts list is arranged into the following sections:

Section	Page
9.1 Housing, Gearing, and Motor Parts.....	48
9.2 Electric, Hook and Chain Parts.....	50

In the column "Parts Per Hoist" a designator is used for parts that apply only to a particular model or option. Refer to Section 2 for hoist model numbers and additional descriptions. The designators are:

## 9.1 HOUSING, GEARING, AND MOTOR PARTS

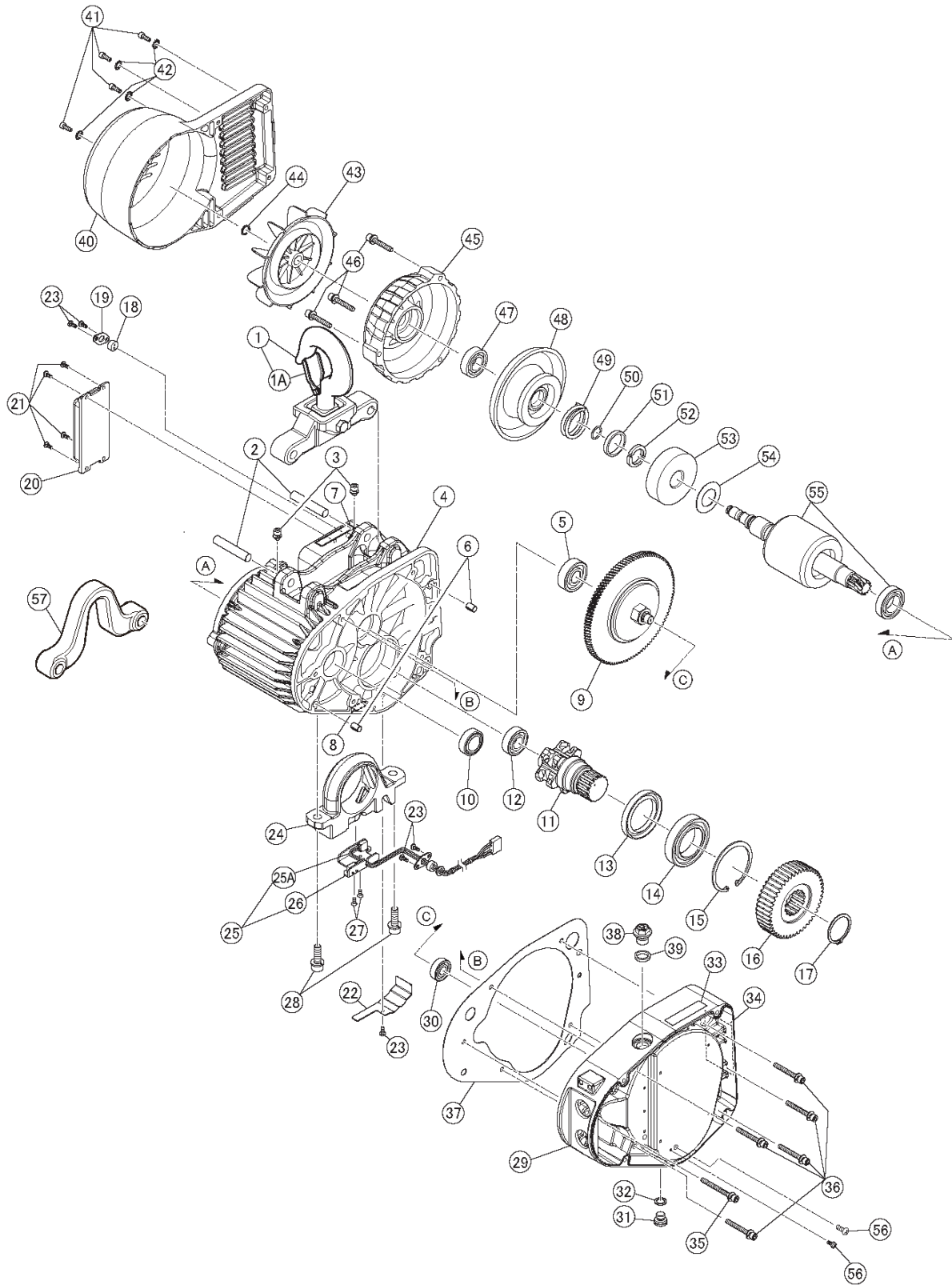

Figure 9-1-1 Housing, Gearing, and Motor Parts



## 9.1 Housing, Gearing, and Motor Parts

Figure No.	Part Name	Parts Per Hoist	001SD	003SD	005SD	010SD
1	Top Hook	1		EQ1CI10131		EQ1DI10131
1A	Latch assembly	1		ER2CS9002		ER2DS1002
2	Top pin	2		EQ1CI9121		EQ1DI9121
3	Machine screw socket bolt w/ spring washer	2		J1BG1-0601010		
4	Body with stator	1	EQ1BVC03I5A1		EQ1BVC05I5A1	EQ1BVC10I5A1
5	Ball bearing	1		J1GR000-06202		
6	Set Pin S	2		E6SE005S9120		
7	Warning sticker HW	1		EQ1DI9845		
8	Name plate side E	1		ER1BS9960		
9	Friction clutch complete set	1	EQ1CG1223	EQ1CF1223	EQ1CI1223	EQ1DI1223
10	Oil seal	1		EQ1CI9244		EQ1DI9244
11	Load sheave	1		EQ1CI9241		EQ1DI9241
12	Ball bearing	1		J1GR0C0-06005		J1GR0C0-06006
13	Oil seal	1		EQ1CI9245		EQ1DI9245
14	Ball bearing	1		E3S231-003S		E1R243-010S
15	Snap ring	1		E3S203-050S		E3S209-020S
16	Load gear	1	EQ1CG9240	EQ1CF9240	EQ1CI9240	EQ1DI9240
17	Snap ring	1		J1SS000-00034		JISS000-00040
18	Packing	1		EQ1DI9187		
19	Cable holder	1		EQ1DI9153		
20	Braking resistor assembly	1		INV705E16		INV715E16
21	Machine screw with spring washer	2		J1AP2-4001010		
22	Limit switch cord cover	1		EQ1CI9151		EQ1DI9151
23	Machine screw with spring washer	1		J1AP2-4001010		
24	Chain guide	1		EQ1CI9331		EQ1DI9331
25	Limit switch complete set	1		EQ1CI1333		EQ1DI1333
27	Machine screw	1		J1AL2-4001010		
28	Machine screw socket bolt w/ spring washer	1		J1BG1-0802525		J1BG1-1003030
29	Gear case	1		EQ1CI9110		EQ1DI9110
30	Ball bearing	1		J1GR0A0-06200		CF130-010
31	Oil plug	1		E5FE003S9111		
32	Plug packing	1		E2YS005-9109		
33	Name plate OF	1		ER2CS9845		
34	Name plate SP	1		EQ1BHQ10I9B6		
35	Machine screw socket bolt	1		J1BG1-0603030		
36	Machine screw socket bolt	5		J1BG1-0605050		
37	Packing G	1		EQ1CI9116		EQ1DI9116
38	Oil plug B	1		ER1BS9135		
39	Eyebolt packing	1		E2YS005-9116		
40	Fan cover	1		EQ1CI9107		EQ1DI9107
41	Socket bolt	1		T1CR131705014		
42	Toothed lock washer	1		J1WH012-10050		
43	Fan	1		ER2BS9108		ER2CS9108
44	Snap ring	1		E2R323-001H		
45	Motor cover	1		EQ1CI9106		EQ1DI9106
46	Machine screw socket bolt	1		J1BG1-0605050		J1BG1-0604040
47	Ball bearing	1		E3S202-005S		J1GR0C0-06004
48	Brake drum assembly	1		EQ1CI5212		EQ1DI5212
49	Brake spring	1	EQ1CF9214		EQ1CI9214	EQ1DI9214
50	O ring	1		E1R126-010S		J1OP011-00160
51	Collar	1		E5FE003S9506		E5FE005S9506
52	Thrust disc	1		E5FE003S9505		E5FE005S9505
53	Pull rotor	1		E5FE003S9503		E5FE005S9503
54	Coned disc spring	1		E5FE003S9504		E5FE005S9504
55	Motor shaft with rotor	1		EQ1CF5502		EQ1CI5502
56	Machine screw with spring washer	1		J1AP2-4001010		MSS54010
57	Optional suspension bar (standard with trolley)	1		EQ1CI9001		EQ1DI9001
57a	Thin Spacer L (standard with Suspension Bar)	2		T7PA005-9301		T7GA010-9303

## 9.2 ELECTRIC, HOOK, AND CHAIN PARTS

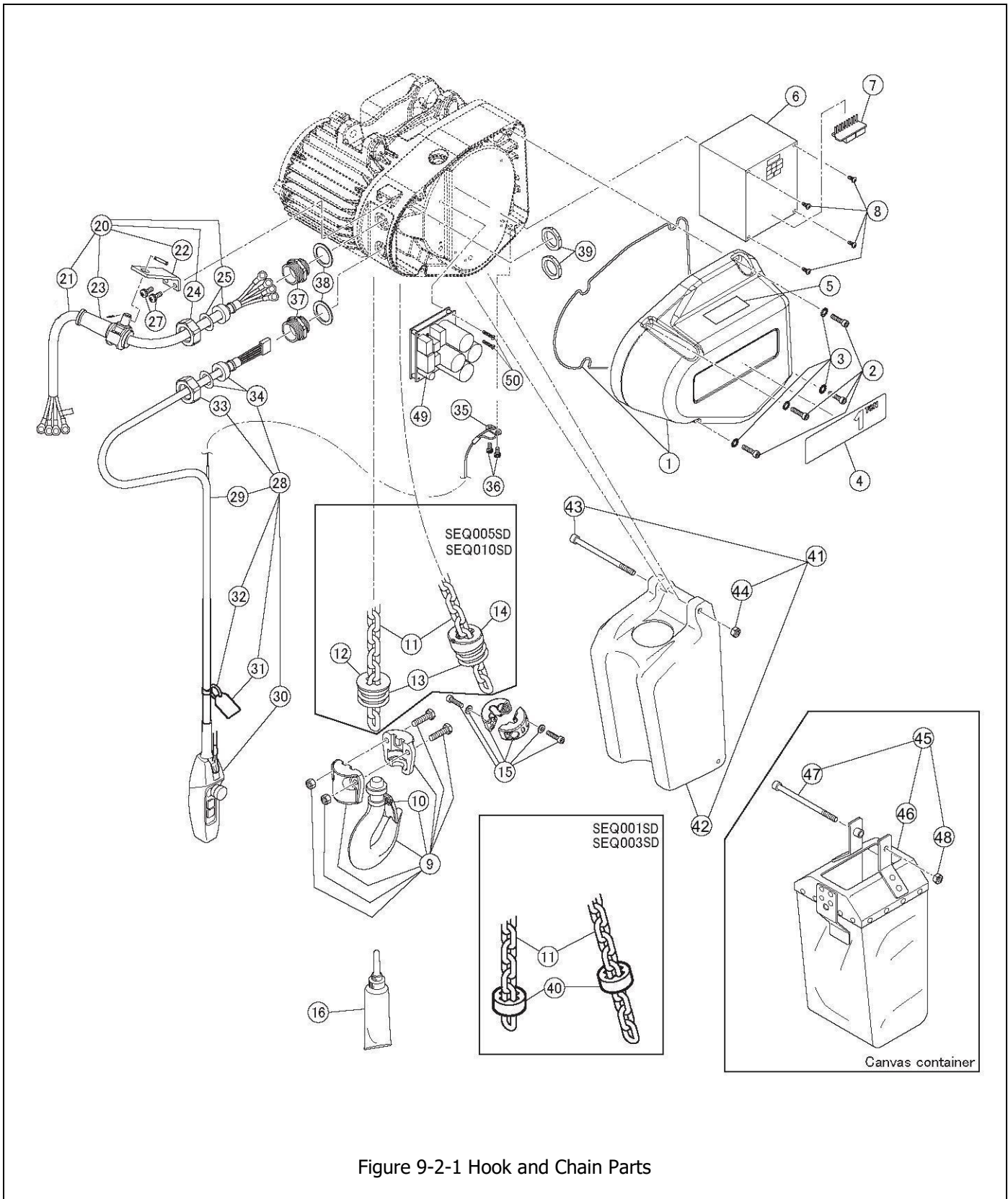

Figure 9-2-1 Hook and Chain Parts

9.2 ELECTRIC, HOOK, AND CHAIN PARTS

Figure No.	Part Name	Parts Per Hoist	001SD	003SD	005SD	010SD
1	Controller cover assembly	1	EQ1CI2104			EQ1DI2104
2	Socket bolt	2	E6F156-0055			
3	Toothed lock washer	2	J1WH012-10060			
4	Name plate B	1	EQ1BUQ01I9A3	EQ1BUQ03I9A3	EQ1BUQ05I9A3	EQ1BUQ10I9A3
5	Warning sticker E	1	EQP1DI9936			
6	Inverter assembly	1	INV60FC44	INV60FC41	INV60FC47	INV615C51
7	HBB board	1	ECP91KB22			
8	Machine screw with spring washer	2	J1AP2-4001010			
9	Bottom hook complete set	1	EQ1CG1011	EQ1CF1011	EQ1CI1011	EQ1DI1011
10	Hook latch assembly	1	ER2CS9002			ER2DS1002
11	Load chain	1	LCEQ005			LCEQ010
12	Limiting plate	1			EQ1CI9054	EQ1DI9054
13	Chain spring	2			EQ1CI9051	EQ1DI9051
14	Spring guide	1			EQ1CI9055	EQ1DI9055
15	Stopper assembly	1	ER1CS1041			ER1DS1041
16	Lubricant tube assembly	1	ER2CS1951			
20	Power supply cable 4C assembly	ft	ZLZH11AV1000			ZLZH11BV1000
21	Power supply cable 4C	1	Z2CC402		Z1CC403	
22	Cable support arm	1	ER1BS9541			
23	Cable support 12/16 assembly	1	M3ES0101724			ECP5900CA
24	Holder A	1	ECP5924AA			
25	Cable packing	1	ECP6916AA		ECP6918AA	
27	Machine screw with spring washer	1	ES650005S			
28	Pendant w/cord complete assembly	1	ZLD001AV1000			
29	Push button cord 5C	1	18/5P			
30	3 push button switch assembly	1	SWJH200AD			
31	Warning tag PB	1	SWJ9013AV			
32	Tag holder	1	E3S787003			
33	Holder A	1	ECP5924AA			
34	Cable packing	1	ECP6912AA			
35	Cord support (wire stopper)	1	ER1BS9534			
36	Machine screw with spring washer	1	J1AP2-5001212			
37	Holder B	1	ECP5924AB			
38	Holder packing	1	ECP5924AQ			
39	Holder nut	1	ECP5924AD			
40	Cushion rubber	1	ER1CS9053			
41	Plastic chain container complete set (20' max lift)	1	EQ1CI1401			EQ1DI1401
42	Plastic chain container	1	EQ1CI9401			EQ1DI9401
43	Socket bolt	1	J1BE1-0809028			J1BE1-0812028
44	Lever nut	1	C2BA100-9074			
45	Canvas chain container complete set (49' max lift)	1	EQ1CI1405			
46	Canvas chain container	1	EQ1CI5405			
47	Socket bolt	1	J1BE1-0809028			
48	Lever nut	1	C2BA100-9074			
49	Dual Power Converter (DPC)	1	ECP91KB64			
50	Machine screw with spring washer	2	J1AP2-4001010			
*	115V Check Voltage Label	1	HAH80612			
*	230V Check Voltage Label	1	HAH80611			

KITO Canada Inc. West  
309-3815 1<sup>st</sup> Avenue  
Burnaby, BC V5C 3V6  
Phone: 604-291-9955  
Toll Free: 1-888-322-KITO  
Fax: 604-294-8855

**KITO**

[www.kito.ca](http://www.kito.ca)

KITO Canada Inc. East  
6-1750 Courtney Park Drive E.  
Mississauga, ON L5T 1W1  
Phone: 905-405-0905  
Toll Free: 1-888-322-KITO  
Fax: 905-405-0906